

- D** Elektroanlage für Anhängervorrichtung Montage- und Betriebsanleitung, Originalbetriebsanleitung
- CZ** Elektrické zařizení pro tažné zařizení Montážní a provozní návod
- DK** Elsæt til anhængertræk Montage- og driftsvejledning
- E** Instalación eléctrica para el dispositivo de remolque Instrucciones de montaje y de servicio
- F** Installation électrique pour dispositif d'attelage Notice de montage et d'utilisation
- FIN** Vetolaitteen sähköjärjestelmä Asennus- ja käyttöohjeet
- GB** Electrical system for trailer hitch Installation and Operating Instructions
- GR** Ηλεκτρικό σύστημα για διάταξη ρυμούλκησης Οδηγίες συναρμολόγησης και λειτουργίας
- HU** Elektromos felszerelés a vonószerkezethez Beszerelési utasítás
- I** Impianto elettrico per gancio di traino Istruzioni di montaggio e per l'uso
- N** Elektrisk anlegg for tilhengerfeste Monterings- og bruksanvisning
- NL** Elektrische installaties voor aanhanger Montage- en gebruikshandleiding
- PL** Instalacja elektryczna do haka holowniczego Instrukcja montażu i eksploatacji
- RUS** Электрооборудование для фаркопа Инструкция по монтажу и эксплуатации
- S** Elsystem för dragkrok Monterings- och bruksanvisning

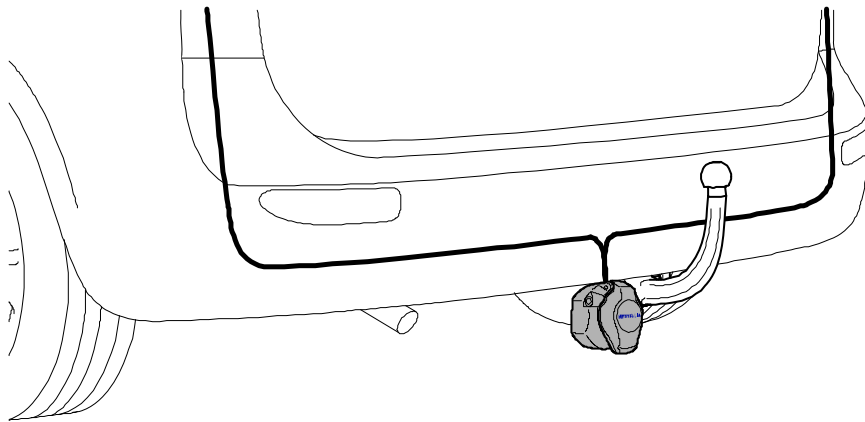

316 334 300 113

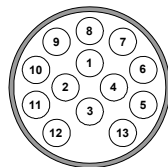

Dacia Dokker Express, 2013 →

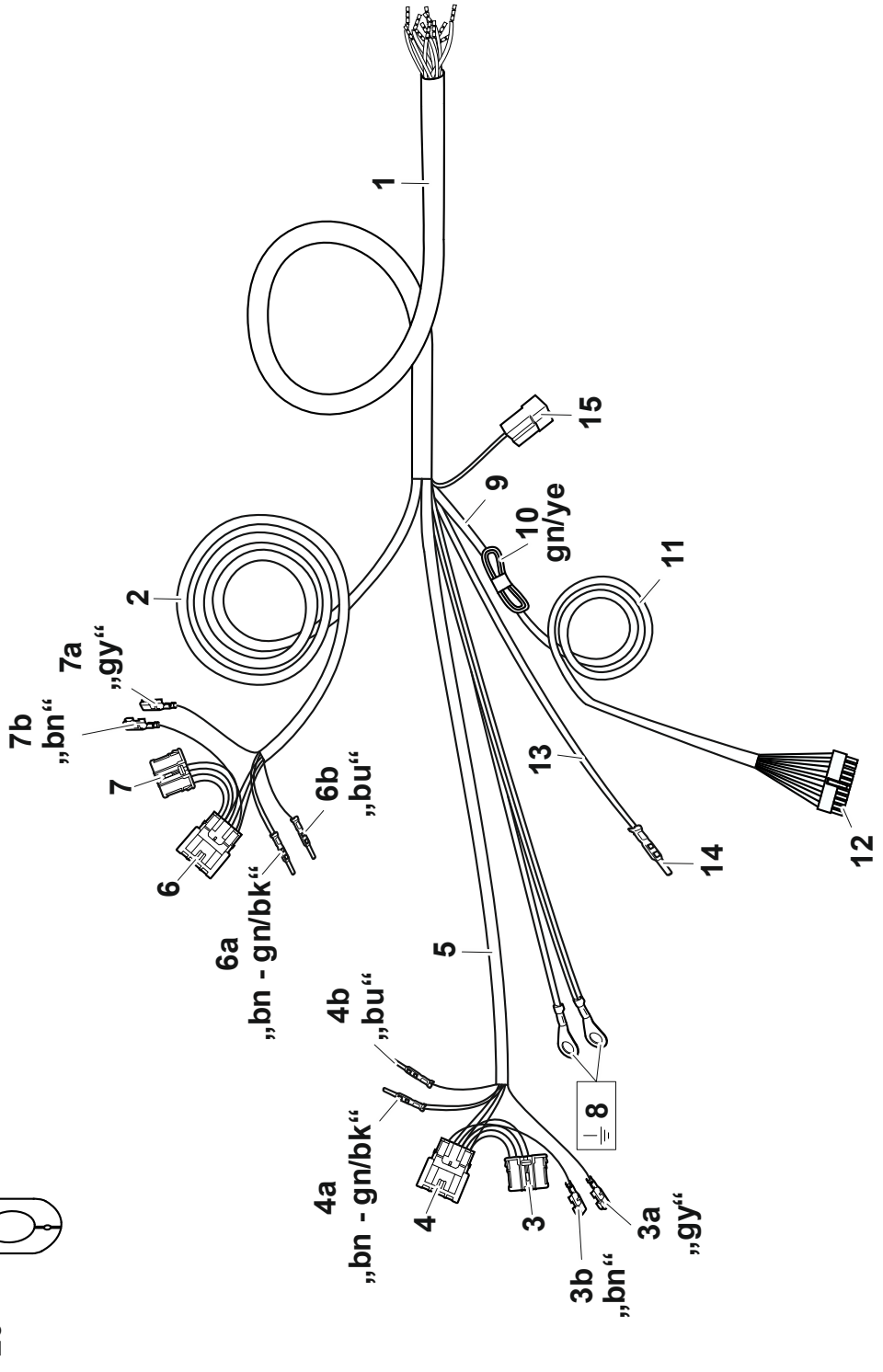
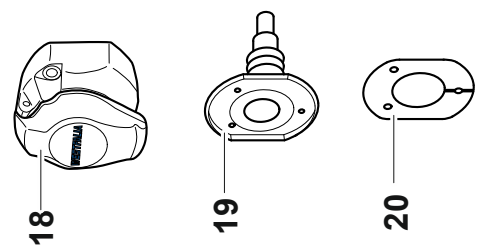
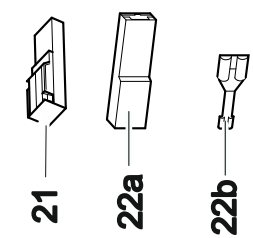
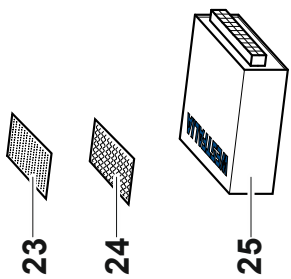
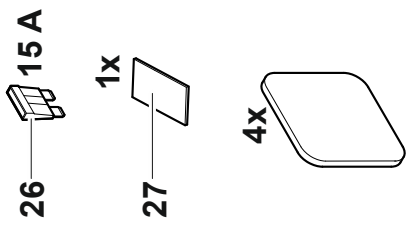
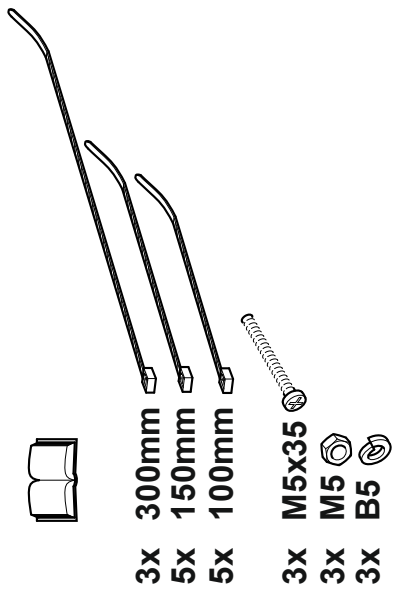

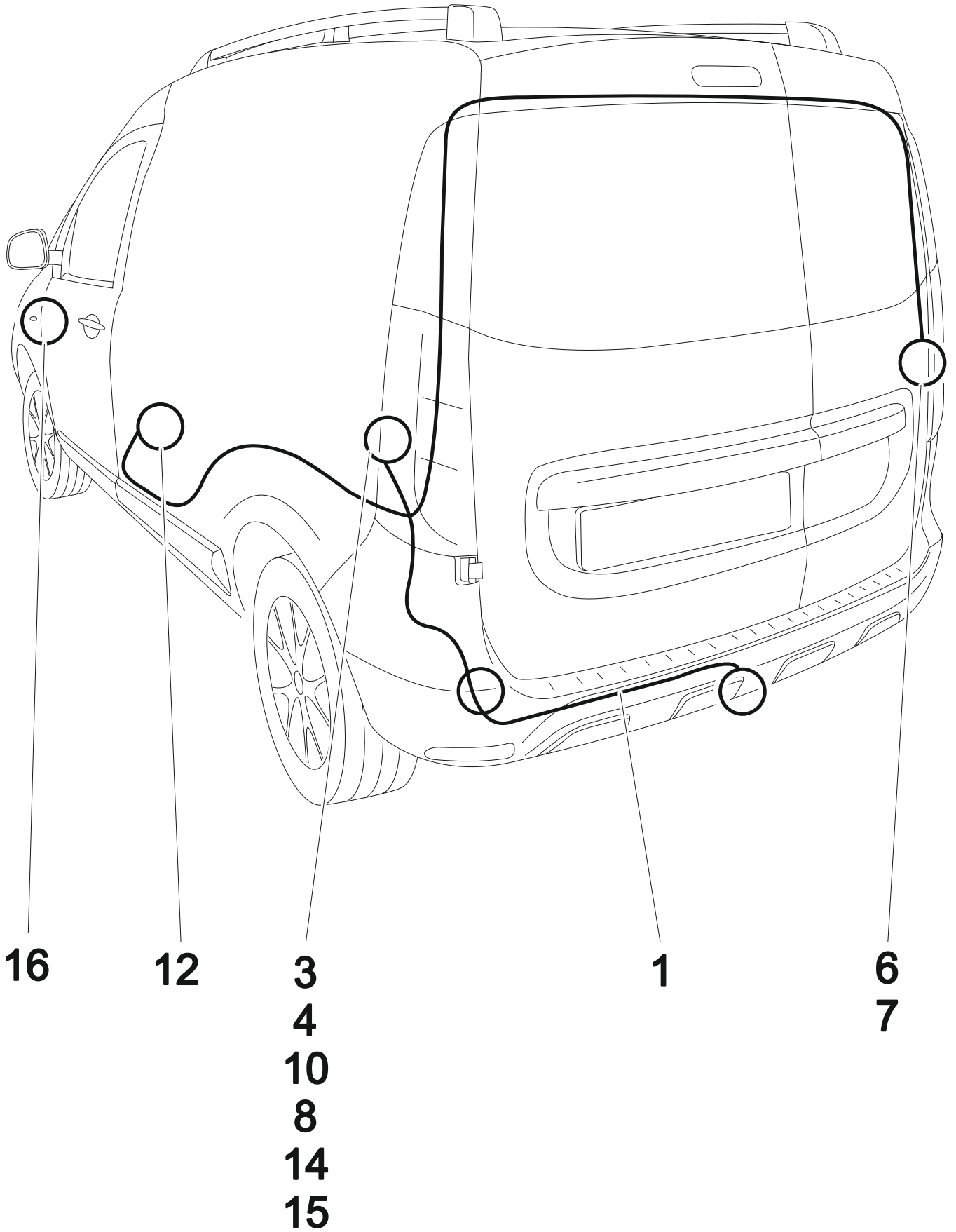





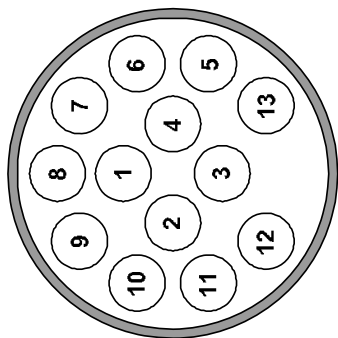







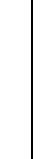



D	Steckdosenbelegung	CZ	Obsazení zásuvky	DK	Koblingskema
E	Esquema de tomas de enchufe	F	Affectation des prises électriques	FIN	Pistorasian navat
GB	Pin assignment	GR	Αντιστοιχία πρίζας	HU	Csatlakozódugó leosztása
I	Schema dei collegamenti della presa	N	Kontaktskjema	NL	Contactdoosbezetting
PL	Rozkład pinów	RUS	Разводка розеток	S	Stickdosschema



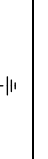

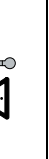

ISO 11446

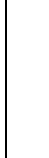

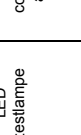
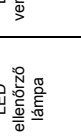
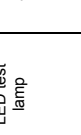
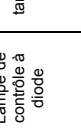

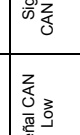

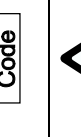

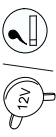
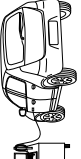

	S	RUS	PL	NL	N	I	HU	GR	GB	FIN	F	E	DK	CZ	D	Leistung / Power		
1 (L)	svart/ vit	черный/ белый	czarno/ biały	zwart/ wit	svart/ hvit	nero/ bianco	fekete/fe hér	μαύρο/ λευκό	black/ white	musta/valkoinen	noir/ blanc	negro/ blanco	sort/hvid	černobílá	schwarz/ weiß	21 W	1	
2 (54g)	vit	белый	biały	wit	hvit	bianco	fehér	λευκό	white	valkoinen	blanc	bianco	hvid	bílá	weiß	Min. 21 W Max. 42 W	2	
3 (31)	svart	черный	czarno	zwart	svart	nero	fekete	μαύρο	black	musta	noir	negro	sort	černý	schwarz		3	
4 (R)	svart/ grön	черный/ зеленый	czarno/ zielony	zwart/ groen	svart/ grønn	nero/ verde	fekete/zöld	μαύρο/ πράσινο	black/ green	musta/vihreä	noir/vert	negro/ verde	sort/grøn	černo zelená	schwarz/ grün	21 W	4	
5 (58R)	grå/ röd	серый/красный	szaro/ czerwony	grijs/ rood	grå/rød	grigio/ rosso	szürke/piros	γκρι/ κόκκινο	gray/ red	harmaa/punainen	gris/rouge	gris/rojo	grå/rød	šedo červená	grau/rot		5	
6 (54)	svart/ röd	черный/красный	czarno/ czerwony	zwart/ rood	svart/ rød	nero/ rosso	fekete/piros	μαύρο/ κόκκινο	black/ red	musta/punainen	noir/rouge	negro/ rojo	sort/rød	černo červená	schwarz/ rot		6	
7 (58L)	grå/ svart	серый/чёрный	szaro/ czarny	grijs/ zwart	grå/ svart	grigio/ nero	szürke/kete	γκρι/ μαύρο	gray/ black	harmaa/ musta	gris/noir	gris/ negro	grå/sort	šedočerná	grau/schwarz		7	
8	grön	зеленый	zielony	groen	grønn	verde	zöld	πράσινο	Green	vihreä	vert	verde	grøn	zelená	grün		8	
9 (+30)	röd	красный	czerwony	rood	rød	rosso	piros	κόκκινο	red	punainen	rouge	rojo	rød	červená	rot		9	
10 (+15)	gul	желтый	żółty	geel	gul	giallo	sárga	κίτρινο	yellow	keltainen	jaune	amarillo	gul	žlutá	gelb		10	
11 (31)	svart/ gul	Черный/ желтый	czarno/ żółty	zwart/ geel	svart/ gul	nero/ giallo	fekete/sárga	μαύρο/ κίτρινο	black/ yellow	musta/keltainen	noir/ jaune	negro/ amarillo	sort/ gul	černý/ žlutá	schwarz/ gelb		11	
12	--	--	--	--	--	--	--	--	--	--	--	--	--	--	--		12	
13 (31)	svart	черный	czarno	zwart	svart	nero	fekete	μαύρο	black	musta	noir	negro	sort	černý	schwarz		13	

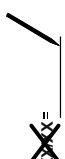
	bk	wh	bn	gn	gy	rd	ye	bu	or	pu	pi
D	schwarz	weiß	braun	grün	grau	rot	gelb	blau	orange	violett	rosa
CZ	černo	bílá	hnědá	zelená	šedo	červená	žlutá	modrý	oranžový	fialový	růžová
DK	sort	hvid	brun	grøn	grå	rød	gul	blå	orange	violet	rosa
E	negro	blanco	marrón	verde	gris	rojo	amarillo	azul	anaranja-do	violeta	rosa
F	noir	blanc	marron	vert	gris	rouge	jaune	bleu	orange	violet	rose
FIN	musta	valkoinen	ruskea	vihreä	harmaa	punainen	keltainen	sininen	oranssi	violetti	rosa
GB	black	white	brown	green	grey	red	yellow	blue	orange	purple	pink
GR	μαύρο	λευκό	καφέ	πράσινο	γκρι	κόκκινο	κίτρινο	μπλε	πορτοκαλί	Μωβ	ροζ
HU	fekete	fehér	barna	zöld	szürke	piros	sárga	kék	narancssárga	ibolyakék	rózsaszín
I	nero	bianco	marrone	verde	grigio	rosso	giallo	blu	arancione	viola	rosa
N	svart	hvit	brun	grønn	grå	rød	gul	blå	oransje	fiolett	rosa
NL	zwart	wit	bruin	groen	grijs	rood	geel	blauw	oranje	violet	rosé
PL	czarno	biały	brązowo	zielony	szaro	czerwonony	żółty	niebieski	pomarańczowe	fioletowe	różowa
RUS	черный	белый	коричневый	зеленый	серый	красный	желтый	голубой	оранжевый	пурпурный	розовый
S	svart	vit	brun	grön	grå	röd	gul	blå	orange	violett	rosa

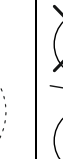
																																																																																																																																																																																																																																																																																																																																																																												
---	---	---	---	---	---	---	---	---	---	--	---	---	---	---	---	---	---	---	---	---	---	---	---	---	---	---	---	---	---	---	---	---	---	---	---	---	---	---	---	---	---	---	---	---	---	---	---	---	---	---	---	---	---	---	---	---	---	---	---	---	---	---	---	---	---	---	---	---	---	---	---	---	---	---	---	---	---	---	---	---	---	---	---	---	---	---	---	---	---	---	---	---	---	---	---	---	---	---	---	---	---	---	---	---	---	---	---	---	---	---	---	---	---	---	---	---	---	---	---	---	---	---	---	--	--	--	--	--	--	--	--	--	--	--	--	--	--	--	--	--	--	--	--	--	--	--	--	--	--	--	--	--	--	--	--	--	--	--	--	--	--	--	--	--	--	--	--	--	--	--	--	--	--	--	--	--	--	--	--	--	--	--	--	--	--	--	--	--	--	--	--	--	--	--	--	--	--	--	--	--	--	--	--	--	--	--	--	--	--	--	--	--	--	--	--	--	--	--	--	--	--	--	--	--	--	--	--	--	--	--	--	--	--	--	--	--	--	--	--	--	--	--	--	--	--	--	--	--	--	--	--	--	--	--	--	--	--	--	--	--	--	--	--	--	--	--	--	--	--	--	--	--	--	--	--	--	--	--	--	--	--	--	--	--	--	--	--	--	--	--	--	--	--	--	--	--	--	--	--	--	--	--	--	--	--	--	--	--	--	--	--	--	--	--	--	--	--	--	--	--	--	--	--	--	--	--	--	--	--	--	--	--	--	--	--	--	--	--	--	--	--	--	--	--	--	--	--	--	--	--	--	--	--	--	--	--	--	--	--	--	--	--	--	--

												
D	keine Feuchtigkeit	LED Prüflampe	Rechtslenker	Linkslenker	mit Einparkhilfe	ohne Einparkhilfe	Datenbusleitung (CAN)	CAN High Signal	CAN Low Signal	Klebeband	Radio Codierung beachten	Achtung! Säure
E	No hay humedad	Lámpara de prueba de LED	con dirección a la derecha	con dirección a la izquierda	con asistencia de estacionamiento	sin asistencia de estacionamiento	Cable de bus de datos (CAN)	Señal CAN High	Señal CAN Low	Perforar agujero de carrocería y sellarlo	Tener en cuenta código radio	¡Atención! Ácido
F	Pas d'humidité	Lampe de contrôle à diode	Direction à droite	Direction à gauche	Avec aide au stationnement	Sans aide au stationnement	Câble de bus de données (CAN)	Signal CAN haut	Signal CAN faible	Perçage et masticage des trous de carrosserie	Attention à la codification radio	Attention ! Acide
FIN	ei kosteutta	LED tarkastuslamppu	Ohjauksuunta puolella	Ohjauksen vasemmalla puolella	Pysäköintipuoli	Ei pysäköintipuolia	Tietoväylä (CAN)	CAN – signaali korkealla	CAN-signaali matalalla	Kori, poraa reikä ja tiivistä	Huomaa radio-koodaus	Huomio! Happoa
GB	no lubrication	LED test lamp	right-hand drive vehicle	left-hand drive vehicle	with parking aid	without parking aid	data bus cable (CAN)	CAN high signal	CAN low signal	drill and seal bodywork hole	observe radio coding	Warning! acid
GR	όχι υγρασία	Λυχνία ελέγχου LED	Δεξιόημιο	Αριστερόημιο	Με σύστημα παρακάρια	Χωρίς σύστημα παρακάρια	Αγωγός διαύλου δεδομένων (CAN)	Σήμα CAN High	Σήμα CAN Low	Διτρήσει και σφραγίσει το ήτλο στο αυτοκίνητο	Προσοχή στην συμπιαστική κωδικοποίηση	Προσοχή! Οξύ
HU	nedvességmentes	LED ellenőrző lámpa	jobb kormány	balkormány	beparkolóval támogatással	beparkolás támogatás nélkül	adatszállítókabel (CAN)	CAN High jel	CAN Low jel	lyuk fúrás a karosszérián és lezárás	a rádió kódolásra figyelni	Figyelem! Sav
I	assenza di umidità	Luce di verifica LED	Guida a destra	Guida a sinistra	con ausilio al parcheggio	senza ausilio al parcheggio	Linea bus dati (CAN)	Segnale CAN High	Segnale CAN Low	Trapanare e sigillare i fori carrozzeria	Rispettare codifica radio	Attenzione! Acido
N	ingen fuktighet	LED testlampe	Ratt på høyre side	Ratt på venstre side	med parkeringsassistent	uten parkeringsassistent	Databusbinding (CAN)	CAN High-signal	CAN Low-signal	Bore og forsegle hull i karosseriet	Vær oppmerksom på radokoding	Obs! Syre
NL	Geen vocht	LED controlelampje	Stuur rechts	Stuur links	Met parkeer-sensor	Zonder parkeer-sensor	Gegevensbuslijn (CAN)	CAN High Signal	CAN Low Signal	Carrosserie gat boren en verzegelen	Radio-codering in acht nemen	Opgelet! Zuren
PL	Brak wilgoci	Lampka kontrolna LED	Kierownica z prawej strony	Kierownica z lewej strony	z asystentem parkowania	bez asystenta parkowania	Przewód magistrali danych (CAN)	CAN High Signal	CAN Low Signal	Wykonać otwór w karoserii i zabezpieczyć.	Uwaga! Kwas	Uwaga! Kwas
RUS	Нет жидкости	Светодиодная контрольная лампа	Автомобиль с правосторонним расположением рулевого управления	Автомобиль с левосторонним расположением рулевого управления	С парковочным радаром	Без парковочного радара	Однопроводная шина данных (CAN)	Сигнал CAN High	Сигнал CAN Low	Просверлить и запечатать отверстие в кузове	Учитывать кодировку радио	Внимание! Кислота
S	ingen fukt	LED kontrollampa	Högerstyrt fordon	Vänsterstyrt fordon	med parkeringshjälp	utan parkeringshjälp	Databussledning (CAN)	CAN High Signal	CAN Low Signal	Borra och förseglå karosseriåttå	Observera radiokodning	Observera Syra

											
D	Zigarettenanzünder, 12V Steckdose	Fahrzeug Kabelfarbe / Test/Programmiergerät	Funktion Kabelfarbe ausmessen / vergleichen	abweichende Kabelfarbe notieren	Funkschlüssel / Chipcard 10m vom Fahrzeug entfernen!	Taster im Fahrzeug vorhanden ja / nein	verbinden	trennen	Signalgeber	beachten / erkennen	Signal Anhänger erkannt
CZ	Zapalovač, 12V zásuvka	Test vozidla / programova cí zařizení	Zjistit/porovnat barvu kabelu	Zaznamenaná odlišnou barvu kabelu	Vzdálit se s dálkovým ovládním nebo čipovou kartou 10 m od vozidla	Tlačítko je/není k dispozici ve vozidle	Spojít	Rozpojit	Upozornění	Prohlédnout /zhodnotit	Rozpoznání signálu přívěsu
DK	Cigaret tænder, 12V stikkåse	Køretøj Test/Programmeringsenhed	Funktion kabelfarve ud mål/ sammenlign	Notér afvigende kabelfarve	Trådløs nøgle / chipcard 10 m væk fra køretøjet!	Finder der en knapp i køretøjet ja / nej	tilslut	adskil	Signalgiver	bemærk / registrere	Signal anhænger registreret
E	Encendedor de cigarrillos, enchufe de 12V	Appareil de prueba/programación de vehículo	Función Medir/comparar color de cable	Anotar color de cable diferente	Alejar llave inalámbrica / Chipcard 10m del vehículo!	Existe pulsador en el vehículo sí / no	unir	separar	Emisor de señales	observar / reconocer	Señal remolque detectada
F	Prise allume-cigares 12V	Appareil de programmation automatique du véhicule	Mesurer/comparer couleur de câble de fonction.	Noter différence de couleur câble	Eloigner de 10 m du véhicule la clé de radiocommande	Touche dans le véhicule oui / non	connecter	séparer	Avertisseur	observer / identifier	Signal remorque identifié
FIN	Savukkeensytyin, 12V-pistoke	Ajoneuvo-testi/ohjelmointilaitte	Kaapelivärin toimitto, mittaa ja vertaa	Merkitse poikkeava kaapeliväri muistiin	Vie radioaivain / sirukortti 10 m päähan ajoneuvosta	Painike ajoneuvossa kyllä/ei	yhdistä	erota	Merkinantolaitte	huomaa/ tunnista	Perävaunun signaali tunnistettu
GB	cigarette lighter, 12V socket	vehicle test/programming equipment	measure / compare function cable colour	note different cable colours	remove remote key / chipcard to 10m away from the vehicle	switch available in vehicle yes / no	connect	disconnect	signal transmitter	observe / recognize	trailer signal recognized
GR	Ανατρίπος, 12V πρίζα	Συσκευή δοκιμής/πρωτοτύπου οχήματος	Λειτουργία μέτρησης/σύνθεσης/σύγκρισης χρώματος καλωδίου	Επισημάνω αποκλιση χρώματος καλωδίου	Απομακρύνω το κλειδί της τηλεχειριστηρίου / την κάρτα chip 10 m από το όχημα!	Υπάρχει πλήκτρο στο όχημα ναι/όχι	Συνδέση	Αποσύνδεση	Κωδικοποιητής σήματος	Παρατήρη / αναγνώριση	Αναγνώριση σήματος ρυμουγκού έμου
HU	szivagyújtó, 12V-os dugalj	járműteszt/programozó készülék	kábelszín mérése / összehasonlítás funkciói	eltérő kábelszín feljegyzése	A rádiófrekvencia csipcardot / kulcsot / chipkártyát a járműtől 10m-re eltávolítani!	Nyomógomb a járműben igen/nem	összekapcsolás	szétválasztás	jeladó	figyelembe venni / felismerni	Utánfutó jel felismerve
I	Accendisigari, presa da 12 V	Dispositivo di test/programmazione veicolo	Misurare / confrontare funzione colore cavo	Annotare colore cavo divergente	Allontanare a 10 m dal chipcard la chiave con telecomando o la scheda chip!	Tasto presente nel veicolo sì / no	collegare	scollegare	Indicatore di segnale	rispettare / riconoscere	Segnale rimorchio riconosciuto
N	Sigarettenne, 12 V stikkontakt	Kjøretøy test/programmeringsenhed	Måle / sammenligne kabelfarve	noter avvikende kabelfarve	Radio-nøkkel / Chipcard 10 m unna kjøretøyet!	Knapp finnes i kjøretøyet ja / nei	koble til	koble fra	Signalgiver	overhold / registrer	Signal tilhenger registrert
NL	Sigarettenaansteker, 12V stopcontact	Voertuig-test/programmeringsapparaat	Funcitie kabelkleur uitsmeten / vergelijken	Afwijkende kabelkleur noteren	Draadloze sleutel / Chipcard 10m van het voertuig verwijderen!	Knop in het voertuig aanwezig ja / neen	Verbinden	Onderbreken	Signaalgever	Opmerken / herkennen	Signaal aanhangwagen herkend
PL	Zapalniczka, gniazdko 12V	Test pojazdu/luz. program.	Funkcja pomiaru/porównania kolorów kabli	zauważać różniące się kolory	Klucz zdalny/karta chipowa oddlegość pojazdu maks. 10 m!	Przycisk dostępny w pojeździe tak / nie	połączyć	rozłączyć	Nadajnik sygnału	uwzględnić/rozpoznać	Signal przyczeprzozpoznany
RUS	Прикуриватель, розетка 12 В	Устройство тестирования / программа оования автомобиля	Измерить / сравнить функцию окраски кабеля	Записать отклонение окраски кабеля	Радиоключ / использовать чиповую карту на расстоянии 10 м от автомобиля	Контактный щуп в автомобиле да / нет	Соединить	Разделить	Разделитель	Датчики сигналов	Сигнал прицепа распознан
S	Cigaretändare, 12 V uttag	Fordon test/programmeringsdon	Funktion kabelfärg mäta upp/jämför	Notera avvikande kabelfärg	Trådlös nyckel/avlägsna chipcard 10 m från fordonet	Knapp finns i fordonet Ja/Nej	Anslut	Frånskilj	Signalgivare	Observera/identifiera	Signal släpvragn identifierad

D

Nationale Richtlinien über die Anbauabnahmen sind zu beachten.

Jegliche Änderungen bzw. Umbauten an der Elektroanlage sind verboten. Sie führen zum Erlöschen der Betriebserlaubnis. Vor Arbeitsbeginn die Einbauanleitung lesen.

Wichtig: Prüfen Sie den Inhalt des Sets, bevor Sie mit der Installation beginnen und melden Sie gegebenenfalls Abweichungen. Beginnen Sie erst mit der Installation, wenn Sie über ein vollständiges Set verfügen.

Die Elektroanlage für Anhängervorrichtung darf nur von Fachunternehmen montiert werden. Bei falscher Montage besteht schwere Unfallgefahr!

WESTFALIA-Automotive haftet nicht für Personen- oder Sachschäden beziehungsweise Verluste, die durch die Installation oder eine fehlerhafte Montage oder Nutzung des Produkts verursacht werden.

Arbeiten an Airbags dürfen nur von entsprechend geschultem Personal durchgeführt werden.

Achtung – vor Arbeitsbeginn den Fehlerspeicher auslesen, ggf. Ruhestrom-Erhaltungsgerät verwenden, ansonsten können elektronisch gespeicherten Daten verloren gehen. Batterie abklemmen, um Beschädigungen der KFZ- Elektronik zu vermeiden.

Wichtiger Hinweis: Das Anhängermodul ist diagnosefähig. Wenn die Diagnoseprozesse des Herstellers oder softwareunterstützte Testmechanismen Fehlerberichte erzeugen, die direkt oder indirekt mit dem Betrieb des Anhängers in Zusammenhang stehen, muss das Anhängermodul vom Leitungsstrang des Anhänger Leitungssatzes getrennt werden und ein neuer Diagnoseprozess gestartet werden.

Für technische Änderungen, Software updates, die nach Erst- Inbetriebnahme z.B. durch den Fahrzeughersteller durchgeführt werden und zu Fehlfunktionen bei Anhängerbetrieb führen, kann keine Gewährleistung übernommen werden.

Leitungen dürfen weder eingeklemmt noch beschädigt sein. Alle Dichtungselemente ordnungsgemäß anbringen.

Bei Anhängerbetrieb wird die Nebelschlussleuchte des Zugfahrzeugs abgeschaltet.

Ein Steckdosenadapter darf nur im Anhängerbetrieb genutzt werden.

- Der Ausfall der Anhängerblinkleuchten wird durch
- ein akustisches Signal gemeldet.

Die Prüfung der Anhängerfunktionen mit einem Anhänger oder einem Prüfgerät mit Belastungswiderständen durchführen.

Achtung! Es ist sicherzustellen das alle Anforderungen des Fahrzeughersteller zu Änderungen und Nachrüstungen am Fahrzeug und/oder Kühlsystem für den Betrieb mit Anhänger durchgeführt wurden.

Der deutsche Text dieser Anleitung ist bindend.

Änderungen vorbehalten.

CZ

Je nutné dodržovat místní směrnice o demontáži nástaveb.

Veškeré změny příp. přestavby elektrického zařízení jsou zakázány. Mají za následek zánik platnosti povolení k provozu.

Před zahájením práce si prostudujte návod k montáži.

Důležité: Před montáží zkontrolujte obsah soupravy a nahláste případné odlišnosti. S montáží začněte pouze v případě, že máte k dispozici kompletní soupravu.

Elektrické zařízení pro tažné zařízení smí montovat pouze odborné podniky. Při chybné montáži hrozí vážné nebezpečí nehody! Společnost WESTFALIA-Automotive není zodpovědná za případná zranění, škody na majetku nebo ztráty na zisku, které mohou být způsobeny chybnou montáží nebo nesprávným používáním výrobku.

Práce na airbagů by měl provádět pouze řádně vyškolení pracovníci.

Pozor – před zahájením práce načtěte paměť chyb, popř. použijte zařízení pro udržení klidového proudu, jinak můžete ztratit elektronicky uložená data. Odpojte akumulátorovou baterii, aby nedošlo k poškození elektronické soustavy vozidla.

Důležitá poznámka: Na jednotce přívěsu je možné provádět diagnostiku. Pokud diagnostika výrobce nebo softwarové testy vykazují chybové hlášky, které přímo či nepřímo souvisí s provozem přívěsu, je nutné odpojit kabely jednotky přívěsu ze zásuvky a spustit novou diagnostiku.

Neneseme žádnou zodpovědnost za technické změny a aktualizace softwaru provedené po prvním uvedení do provozu (např. výrobcem vozidla), které mohou způsobit nesprávnou funkci přívěsu.

Vodiče nesmí být sevřené ani poškozené. Všechny těsnicí prvky náležitě namontujte.

Při provozu s tažným zařízením se vypne koncové světlo do mlhy na tažném vozidle.

Adaptér zásuvky se smí používat jen při provozu s přívěsem.

- Výpadek směrových světel přívěsu je
- ohlášen akustickým signálem.

Kontrolu funkcí přívěsu provádějte pomocí přívěsu nebo vhodného kontrolního přístroje se zatěžovacími odpory.

Pozor! Ujistěte se, zda jsou splněny všechny podmínky provozu přívěsu stanovené výrobcem vozidla a zda byly provedeny všechny úpravy a dodatečné vybavení vozidla či chladicího systému.

Německý text tohoto návodu je závazný.

Změny vyhrazeny.

De nationale direktiver for montering af tilbehør skal overholdes.

Enhver ændring eller ombygning på el-anlægget er forbudt. Dette medfører, at typegodkendelsen ikke er gældende. Læs monteringsvejledningen inden påbegyndelse af arbejdet.

Vigtigt: Kontrollér sættets indhold inden du begynder med installationen og meddel i givet fald afvigelser. Begynd først installationen, når du har et komplet sæt.

Elsættet til anhængertrækket må kun monteres af kvalificeret personel. Ved forkert montering er der fare for alvorlige fejlfunktioner!

WESTFALIA-Automotive overtager ikke ansvaret for person- eller tingskader henholdsvis for tab, der er forårsaget af en forkert installation, montage eller anvendelse af produktet.

Arbejdet med airbags bør kun udføres af dertil uddannet personale.

Bemærk – udlæs fejlloggen inden påbegyndelse af arbejdet, anvend evt. apparat til opretholdelse af hvilestrøm, ellers kan elektronisk lagrede data gå tabt. Frakobl batteriet for at undgå beskadigelse af personbilens elektronik.

Vigtig information: Anhængermodul er diagnosekompatibelt. Hvis producentens diagnoseprocesser eller softwareunderstøttede testmekanismer genererer fejlrapporter, som hænger direkte eller indirekte sammen med anhængerens drift, skal anhængermodul adskilles fra kablerne til anhængerbøsningen og der skal startes en ny diagnoseproces.

For tekniske ændringer, software-updates, der gennemføres efter den første ibrugtagning, f.eks. af køretøjsproducenten og som medfører fejlfunktioner i anhængerdriften, kan der ikke overtages noget ansvar.

Ledningerne må ikke hverken blive klemt eller beskadiget. Alle tætningselementerne skal anbringes efter forskrifterne.

Ved brug af anhængerens elstik frakobles trækkøretøjs tågebaglygte.

En stikdåseadapter må udelukkende anvendes ved drift med anhænger.

- Hvis anhængerblinklysene er defekte, angives det på denne måde:

- Der lyder et akustisk signal.

Kontrol af anhængerfunktionerne skal foretages med en anhænger eller et kontrolapparat med belastningsmodstand.

OBS! Kontrollér, at alle køretøjsproducentens krav til ændringer og eftermonteringer på køretøj og/eller kølesystem til brug med anhænger er blevet gennemført.

Den tyske tekst i denne vejledning er bindende.

Ret til ændringer forbeholdes.

Deben respetarse las directivas nacionales referentes a controles de enganches.

Está prohibido modificar o remodelar la instalación eléctrica. La consecuencia sería la invalidación del permiso de circulación.

Antes de iniciar la tarea, lea las instrucciones de montaje.

Importante: Verifique el contenido del juego antes de comenzar con la instalación y notifique las diferencias si las hubiera.

Comience con la instalación recién cuando disponga de un juego completo.

La instalación eléctrica para el dispositivo de remolque sólo debe montarla personal cualificado. ¡En caso de montaje erróneo existe peligro de accidentes graves!

WESTFALIA-Automotive no asume ninguna responsabilidad por daños personales o materiales, respectivamente pérdidas, que sean causados por la instalación o por un montaje o uso del producto deficientes.

Trabajo sobre las bolsas de aire sólo debe ser realizada por personal debidamente capacitado.

Atención – antes de iniciar la tarea, leer la memoria de fallos, si es necesario utilizar un dispositivo de mantenimiento de corriente de reposo, de lo contrario podría perder los datos memorizados electrónicamente. Desconecte la batería para evitar daños en la instalación eléctrica del vehículo.

Nota importante: El módulo de remolque posee capacidad de diagnóstico. Si los procesos de diagnóstico del fabricante o mecanismos de prueba soportados por software generan informes de falla, que están relacionados directa o indirectamente con la operación del remolque, se debe desconectar el módulo de remolque de los cables que llevan al terminal de enchufe del remolque y se debe iniciar un nuevo proceso de diagnóstico.

No puede asumirse ninguna garantía por modificaciones técnicas o actualizaciones de software que hayan sido realizadas después de la primera puesta en servicio, p. ej. por el fabricante del vehículo, y que causen funcionamientos defectuosos en la operación del remolque.

Se debe evitar dañar o aprisionar los cables. Instalar correctamente todas las juntas.

Al circular con remolque se desconecta la luz antiniebla trasera del vehículo de tiro.

Sólo se puede usar un adaptador de caja de enchufe cuando se circule con remolque.

- Si se funde alguno de los intermitentes del remolque, ello se indicará mediante

- Una señal acústica.

La comprobación de las funciones del remolque debe efectuarse con un remolque o bien con un equipo de comprobación con resistores reguladores de carga.

¡Atención! Se debe asegurar que se ha cumplido con todos los requerimientos del fabricante del vehículo en lo que respecta a modificaciones y reequipamiento en el vehículo y/o sistema de refrigeración para la operación con remolque.

Es vinculante el texto alemán de estas instrucciones.

Nos reservamos el derecho a efectuar modificaciones.

F

Les dispositions nationales concernant la réception à titre isolé doivent être respectées.

Toute modification ou transformation de l'installation électrique est interdite. Elle entraînerait l'annulation de la réception.

Lire impérativement la notice de montage avant de commencer le travail.

Important : Vérifier le contenu de l'ensemble avant de commencer l'installation et mentionner le cas échéant les anomalies. Ne commencer l'installation que lorsque vous disposez d'un ensemble complet.

Seules des entreprises spécialisées sont autorisées à monter le faisceau électrique du dispositif d'attelage. Un montage incorrect représente un risque élevé d'accident !

WESTFALIA-Automotive n'est pas tenu responsable des dommages aux personnes ou matériels ou bien de pertes qui seraient causés par l'installation ou un montage défectueux ou une mauvaise utilisation du produit.

Travail sur les airbags ne doivent être effectuées que par du personnel formé.

Attention – Avant de commencer le travail, éliminer l'ensemble des défauts présents dans la mémoire de l'ordinateur de bord ou utiliser un générateur de courant de veille pour éviter que des données enregistrées sur support électroniques ne soient perdues. Débrancher la batterie afin d'éviter tout endommagement de l'installation électronique du véhicule.

Information importante : Le module de remorque peut faire l'objet d'un diagnostic. Si les procédures de diagnostic du fabricant ou les mécanismes de contrôle informatisés produisent des rapports de défauts en rapport direct ou indirect avec l'utilisation de la remorque, le module de remorque doit être séparé des câbles allant à la prise de remorque et une nouvelle procédure de diagnostic doit être lancée.

Aucune garantie ne peut être prise en charge eu égard aux modifications techniques, aux mises à jours de logiciel qui sont effectuées après la première mise en marche, par ex. : par le fabricant du véhicule et qui conduisent à des fonctionnements défectueux de la remorque.

Les fils électriques ne doivent être ni endommagés ni coincés. Mettre en place tous les éléments d'étanchéité conformément à la notice.

Lorsqu'une remorque/caravane est attelée, le fonctionnement du feu de brouillard arrière du véhicule tracteur est interrompu.

Un adaptateur pour prise de courant ne doit être utilisé que si une remorque/caravane est tractée.

- La défaillance des clignotants de la remorque est signalée par
- un signal acoustique.

Le contrôle des fonctions de l'attelage doit s'effectuer avec une remorque ou avec un appareil de contrôle muni d'ampoules classiques.

Attention ! Il convient de s'assurer que toutes les consignes imposées du fabricant du véhicule ont été respectées concernant les modifications et les équipements ultérieurs réalisés sur le véhicule et/ou le système de refroidissement pour l'utilisation avec la remorque.

Le texte allemand de cette notice fait foi.

Sous réserve de modifications.

FIN

Kansallisia suuntaviivoja, mitä tulee asennukseen, on noudatettava.

Kaikki sähköjärjestelmään tehtävät muutokset tai jälkiasennukset ovat kiellettyjä. Nämä johtavat käyttöluvan raukeamiseen.

Lue asennusohjeet ennen työskentelyn aloittamista.

Tärkeää: Tarkasta sarjan sisältö, ennen kuin aloitat asennuksen ja ilmoita mahdollisista poikkeamista. Aloita asennus vasta, kun olet varma, että sarja on täydellinen.

Vetolaitteen sähköjärjestelmän saa asentaa vain alan erikoisliike. Virheellinen asennus voi aiheuttaa vakavan onnettomuuden!

WESTFALIA-Automotive ei vastaa henkilö- tai esinevahingoista tai muistakaan vahingoista, jotka ovat seurausta tuotteen virheellisestä asennuksesta tai käytöstä.

Työ turvatyyny saa suorittaa vain asianmukaisesti koulutettu henkilöstö.

Huomio: lue vikamuisti ennen työskentelyn aloittamista. Käytä tarvittaessa lepovirran säilymisen varmistavaa laitetta, jotta elektronisesti tallentuneet tiedot eivät katoa muistista. Irrota akun navat, jotta ajoneuvon elektroniikka ei vaurioidu.

Tärkeä ohje: Perävaunumuoduuli on diagnoosikykyinen. Jos valmistajan diagnoosiprosessit tai ohjelmistotuetut testimekanismit antavat tulokseksi virheraportteja, jotka ovat suorassa tai epäsuorassa yhteydessä perävaunun käytön kanssa, on perävaunumuoduuli erotettava perävaunuliitännän kaapeleista ja uusi diagnoosiprosessi käynnistettävä.

Valmistaja ei vastaa teknisistä muutoksista tai ohjelmistopäivityksistä, jotka toteutetaan ensimmäisen käyttöönoton jälkeen tai ajoneuvon valmistajan toimesta ja joista on seurauksena perävaunun käytön virhetoimintoja.

Johdot eivät saa jäädä puristuksiin eivätkä vaurioitua. Kiinnitä kaikki tiiviste-elementit asianmukaisesti.

Vetoajoneuvon takasumuvälöt eivät toimi vetolaitteen käytön aikana.

Pistorasia-adapteria saa käyttää ainoastaan perävaunun yhteydessä.

- Perävaunun suuntavilkkujen vioittumisesta ilmoittaa
- äänimerkki.

Perävaunuun liittyvät toiminnot on testattava joko perävaunun kanssa tai kuormitusvastuksilla varustetulla testauslaitteella.

Huomio! On varmistettava, että kaikkia ajoneuvon valmistajan ajoneuvon ja/tai jäähdytysjärjestelmään tehtäviin muutoksiin ja jälkivarusteluihin, jotka koskevat perävaunun käyttöä, liittyviä vaatimuksia noudatetaan.

Tämän ohjeen saksankielinen teksti on sitova.

Oikeudet muutoksiin pidätetään.

Observe national guidelines on the approval of accessories.

Any alteration or modification of the electrical system is prohibited and voids the operating licence.

Read the installation manual before beginning to work.

Important: Check contents of kit before commencing installation and report any discrepancies. Do not commence installation unless you have a complete kit.

Only qualified companies may install the electrical system for the trailer hitch. Improper assembly may result in a serious accident hazard!

WESTFALIA-Automotive is not liable for personal injury, damage or loss caused by the installation or improper assembly or use of the product.

Work on airbags should only be performed by properly trained personnel.

Attention – before starting to work, read out the errors stored in the memory. If required, use a power supply to prevent electronically saved data from being erased. Disconnect the battery to prevent damage to the vehicle electronics.

Important: The trailer module is diagnostic capable. If the manufacturer's diagnostic processes or software supported test mechanisms generate error reports directly or indirectly linked with the trailer operation, the trailer module must be disconnected from the leads to the trailer socket and a new diagnostic process initiated.

No guarantee can be given for the malfunctioning of the trailer operation caused by technical changes, software updates, carried out by the vehicle manufacturer, for example, after the initial commissioning.

Verify that no cables are squeezed or damaged. Properly install all seals.

When towing a trailer, the rear fog light of the pulling vehicle is switched off.

An electrical socket adapter may only be used when towing a trailer.

- A failure of the trailer turn signal lamps is indicated by
- an acoustic signal.

Check the trailer functions with a trailer or a testing instrument with load resistors.

Warning! It must be ensured that all the requirements of the vehicle manufacturer for changes to and retro-fitting on the vehicle and / or cooling system for the operation with a trailer are carried out.

The German text of this instruction is binding.

Subject to change.

Πρέπει να τηρούνται οι κρατικοί κανονισμοί σχετικά με τον έλεγχο προσθηκών στα αμαξώματα.

Απαγορεύονται οι αλλαγές και οι μετατροπές στην ηλεκτρική εγκατάσταση. Συναπτόνται την ακύρωση της άδειας λειτουργίας.

Πριν από την έναρξη των εργασιών μελετήστε τις οδηγίες τοποθέτησης.

Σημαντικό: Ελέγξτε το περιεχόμενο του σετ προτού αρχίσετε τις εργασίες εγκατάστασης, και αναφέρετε τυχόν αποκλίσεις. Αρχίστε την εγκατάσταση μόνο εφόσον το σετ που διαθέτετε είναι πλήρες.

Το ηλεκτρικό σύστημα για διατάξεις ρυμούλκησης επιτρέπεται να τοποθετείται μόνο από ειδικά συνεργεία. Σε περίπτωση λάθους τοποθέτησης υπάρχει κίνδυνος σοβαρών ατυχημάτων!

Η WESTFALIA-Automotive δεν φέρει ευθύνη για τραυματισμούς, ζημιές ή απώλειες που προκαλούνται από την εγκατάσταση ή από τυχόν εσφαλμένη τοποθέτηση ή χρήση του προϊόντος.

Οι εργασίες σχετικά με τους αερόσακους θα πρέπει να εκτελείται μόνο από κατάλληλα εκπαιδευμένο προσωπικό.

Προσοχή – Πριν από την έναρξη των εργασιών διαβάστε τη μνήμη σφαλμάτων ή αντίστοιχα χρησιμοποιήστε μία συσκευή διατήρησης ρεύματος. Διαφορετικά μπορεί να χαθούν τα ηλεκτρικά αποθηκευμένα δεδομένα. Αποσυνδέστε την μπαταρία ώστε να αποφευχθούν οι ζημιές στα ηλεκτρονικά του οχήματος.

Σημαντική υπόδειξη: Η μονάδα ρυμουλκούμενου διαθέτει δυνατότητες διάγνωσης. Όταν οι διαγνωστικές διαδικασίες του κατασκευαστή ή οι υποστηριζόμενοι από λογισμικό μηχανισμοί δοκιμής εμφανίζουν αναφορές σφάλματος που σχετίζονται άμεσα ή έμμεσα με τη λειτουργία του ρυμουλκούμενου, η μονάδα ρυμουλκούμενου πρέπει αποσυνδεθεί από τα καλώδια που τη συνδέουν με την υποδοχή σύνδεσης ρυμουλκούμενου και στη συνέχεια να ξεκινήσει μια νέα διαδικασία διάγνωσης.

Για τεχνικές αλλαγές και ενημερώσεις λογισμικού μετά την πρώτη θέση σε λειτουργία που εκτελούνται π.χ. από τον κατασκευαστή του οχήματος και οδηγούν σε σφάλματα λειτουργίας του συστήματος ρυμούλκησης, δεν αναλαμβάνεται ευθύνη.

Τα καλώδια δεν πρέπει ούτε να μαγκώνονται ούτε να είναι χαλασμένα. Τοποθετήστε σωστά όλα τα στοιχεία στεγανοποίησης.

Κατά την οδήγηση με τρέιλερ το πίσω φανάρι ομίχλης του έλκοντος οχήματος απενεργοποιείται.

Ένας προσαρμογέας πρίζας επιτρέπεται να χρησιμοποιηθεί μόνο κατά την οδήγηση με τρέιλερ.

- Σε περίπτωση βλάβης των φώτων φλας της ρυμούλκας
- εκπέμπεται ένα ακουστικό σήμα.

Ο έλεγχος των λειτουργιών της ρυμούλκας πρέπει να γίνεται ή με μία ρυμούλκα ή με μια συσκευή μετρήσεων με ανιστάσεις καταπόνησης.

Προσοχή! Θα πρέπει να διασφαλιστεί ότι έχουν υλοποιηθεί όλες οι απαιτήσεις του κατασκευαστή του οχήματος για μετατροπές και προσθήκες εξοπλισμού στο όχημα ή/και το σύστημα ψύξης, οι οποίες σχετίζονται με τη λειτουργία με ρυμουλκούμενο.

Το γερμανικό κείμενο αυτών των οδηγιών είναι δεσμευτικό.

Διατηρούμε το δικαίωμα αλλαγών.

Figyelembe kell venni a műszaki átvételre vonatkozó nemzeti irányelveket.

Az elektromos felszerelésen tilos bármiféle átalakítást végezni. A szerkezet megváltoztatása vagy átalakítása a forgalmi engedély megszűnését vonja maga után.

A munka megkezdése előtt olvassa el a szerelési útmutatót.

Fontos: A beépítés megkezdése előtt ellenőrizze a garnitúra tartalmát és adott esetben jelentse az eltéréseket. Csak akkor kezdje meg a beépítést, ha teljes garnitúra rendelkezésére áll.

A vonószerkezet elektromos részét csak szaküzem szerelheti be. Helytelen szerelés súlyos balesethez vezethet!

A WESTFALIA-Automotive nem vállal felelősséget a beépítés vagy hibás szerelés vagy a termék használata által okozott személyi sérülésekért vagy dologi károkért.

Végzett munka légzsákok csak akkor kell elvégezni a megfelelően képzett személyzet.

Figyelem – a munka megkezdése előtt olvassa ki a hibatárolót, adott esetben használjon nyugalmi áramot fenntartó készüléket, máskülönben elveszhetnek az elektronikusan tárolt adatok. Kösse le az akkumulátort, hogy megelőzze a gépjármű elektronikájának megrongálódását.

Fontos tájékoztatás: Az utánfutó modul diagnózisképes. Ha a gyártó diagnózis folyamatai vagy szoftverrel támogatott tesztmechanizmusok az utánfutó működésével közvetlenül vagy közvetve összefüggő hibajelentéseket generálnak, akkor az utánfutó modult le kell választani az utánfutó dugaszhüvelyhez menő kábelekről és új diagnózis folyamatot kell indítani.

Az első üzembe helyezés után pl. a járműgyártó által elvégzett és az utánfutó hibás működéséhez vezető műszaki változtatásokért, szoftverfrissítésekért jótállás nem vállalható.

A vezetékek nem lehetnek becsípődve vagy megrongálódva. Minden szigetelő elemet a rendeltetésének megfelelően szereljen.

Utánfutóüzemben ki lesz kapcsolva a vonatjármű hátsó ködlámpája.

Dugóaljzat adaptert csak vonatúzemben szabad használni.

- Az utánfutó indexlámpáinak kiesését
- egy akusztikus hang jelzi.

Ellenőrizze az utánfutó funkciók működését egy utánfutóval vagy egy terhelő ellenállásokkal ellátott ellenőrzőkészülékkel.

Figyelem! Biztosítani kell, hogy a járműgyártónak az utánfutóval történő működtetés érdekében a járművön és/vagy a hűtőrendszeren elvégzendő változtatásokra vonatkozó minden követelménye teljesüljön.

A német szerelési utasítás betartása kötelező.

Változtatások jogát fenntartjuk.

Devono essere osservate le normative nazionali sui collaudi.

È vietato modificare o montare diversamente l'impianto elettrico. Ciò comporta l'annullamento del permesso di circolazione.

Prima di iniziare i lavori, leggere le istruzioni di montaggio.

Importante: Controllare il contenuto del kit, prima di iniziare l'installazione e segnalare eventuali divergenze. Iniziare l'installazione soltanto quando il kit di cui si dispone è completo.

L'impianto elettrico per il gancio di traino deve essere montato solo da personale specializzato. In caso di montaggio errato sussiste il pericolo di incidenti gravi!

WESTFALIA-Automotive non è responsabile per danni a cose o persone o nello specifico di perdite verificatesi in seguito all'installazione, al montaggio o all'uso difettoso del prodotto.

Il lavoro sul airbag deve essere eseguita solo da personale addestrato.

Attenzione – prima di iniziare i lavori, leggere la memoria errori, se necessario utilizzare un dispositivo di mantenimento della corrente di riposo per non perdere i dati memorizzati. Scollegare la batteria al fine di evitare danni all'impianto elettronico del veicolo.

Informazione importante: Il modulo del rimorchio può essere sottoposto a diagnosi. Se i processi di diagnosi del costruttore o i meccanismi di test su base software evidenziano degli errori, che sono in rapporto diretto o indiretto con l'esercizio del rimorchio, il modulo del rimorchio deve essere scollegato dai cavi che conducono al connettore femmina per il rimorchio e si deve avviare un nuovo processo di diagnosi.

Non si assume responsabilità alcuna per modifiche tecniche e aggiornamenti software che vengono effettuati dopo la prima messa in funzione dal costruttore del veicolo e che possono provocare il funzionamento difettoso del rimorchio.

I cavi non devono essere schiacciati né danneggiati. Installare correttamente gli elementi di tenuta.

Durante il funzionamento con rimorchio la luce antinebbia posteriore della motrice viene spenta.

Utilizzare un adattatore per prese esclusivamente per il funzionamento con rimorchio.

- Un eventuale guasto degli indicatori di direzione del rimorchio viene segnalato da:
- Un segnale acustico.

Il controllo delle funzioni del rimorchio deve essere eseguito con un rimorchio o con un apparecchio di controllo con resistenza di carico.

Attenzione! Occorre controllare che vengano rispettati tutti i requisiti del costruttore del veicolo relativi alle modifiche e agli accessori sul veicolo e/o sull'impianto del raffreddamento per l'esercizio del rimorchio.

È vincolante il testo tedesco di queste istruzioni.

Con riserva di modifiche.

N

Nasjonale retningslinjer om godkjenning av monteringer skal overholdes.

Enhver endring hhv. ombygging av det elektriske anlegget er forbudt. Dette vil ødelegge brukeropplevelsen.

Les montasjeveiledningen før man begynner arbeidet.

Viktig: Kontroller innholdet i settet før du starter installasjonen og meld fra om eventuelle avvik. Start installasjonen først når du har et fullstendig sett.

Det elektriske anlegget til tilhengerfestet må kun monteres av fagbedrift. Det er stor fare for at det kan oppstå ulykker ved feil montering!

WESTFALIA-Automotive er ikke ansvarlig for personskader eller materielle skader hhv. tap som skyldes installasjon eller feil montering eller bruk av produktet.

Arbeid på kollisjonsputer bør kun utføres av personell med tilstrekkelig opplæring.

OBS – før arbeidet starter må man lese av feilminnet hhv. benytte hvilestrøms-måleapparat for å unngå at elektronisk lagrede data går tapt. Koble fra batteriet for å unngå at kjøretøyelektronikken skades.

Viktig henvisning: Tilhengermodulen kan diagnostiseres. Hvis diagnoseprosessen til produsenten eller programvarestøttede testmekanismer genererer feilrapporter som er direkte eller indirekte knyttet til driften av tilhengeren, må tilhengermodulen kobles fra kablene til tilhengerkontakten og en ny diagnoseprosess på startes.

Det blir ikke gitt noen garanti for tekniske endringer, programvareoppdateringer som utføres etter første igangkjøring f.eks. av kjøretøyprodusenten, og som fører til funksjonsfeil ved bruk av tilhengeren.

Ledninger må verken klemmes fast eller skades. Alle tettningselementer må monteres på plass i riktig posisjon.

Ved bruk av tilhenger blir baklysene til trekkvognen koblet ut.

Stikkontaktadapteret må kun brukes i kombinasjon med tilhenger.

- Ved svikt i tilhengerblinklys:
- meldes det fra med et akustisk signal.

Kontrollen av tilhengerfunksjonen foretas med en tilhenger eller et kontrollinstrument med belastningsmotstander.

Obs! Man må forsikre seg om at alle kravene til kjøretøyprodusenten vedrørende endringer og etterutrustninger på kjøretøyet og/eller kjølesystemet ble gjennomført for drift med tilhenger.

Den tyske teksten i denne veiledningen er bindende.

Med forbehold om endringer.

NL

Nationale richtlijnen betreffende de montagegoedkeuring moeten in acht worden genomen.

Elke wijziging van de elektrische installatie is verboden. Wijziging leidt tot verval van de gebruikstoestemming.

Voor montage eerst de inbouwhandleiding lezen.

Belangrijk: controleer de inhoud van de set voor u met de installatie begint en meld eventuele afwijkingen. Begin pas met de installatie wanneer u over een volledige set beschikt.

De elektrische installatie voor aanhanger mag alleen door vakkundig personeel worden gemonteerd. Bij verkeerde montage bestaat ernstig gevaar voor ongevallen!

WESTFALIA-Automotive kan niet verantwoordelijk worden gesteld voor materiële schade, lichamelijke letsels of voor mogelijk verlies dat door de installatie, foutieve montage of verkeerd gebruik van het product werd veroorzaakt.

Werkzaamheden aan airbags mag alleen worden uitgevoerd door goed opgeleid personeel.

Attentie – voor montage het foutgeheugen aflezen, eventueel ruststroomapparaat gebruiken, anders kunnen elektrisch opgeslagen gegevens verloren gaan. Los de accu klemmen om beschadiging van de voertuigelektroniek te vermijden.

Belangrijk: de aanhangwagenmodule kan worden gediagnosticeerd. Als de diagnoseprocessen van de fabrikant of software-ondersteunde testmechanismen foutmeldingen genereren die rechtstreeks of onrechtstreeks in verband staan met de werking van de aanhangwagen, moet de aanhangwagenmodule van de kabels tot de aanhangwagenbus losgemaakt worden en een nieuw diagnoseproces worden gestart.

Voor technische wijzigingen, software-updates die na de eerste ingebruikneming (bijv. door de fabrikant van het voertuig) worden uitgevoerd en bij het gebruik van de aanhangwagen tot storingen leiden, kan Westfalia niet verantwoordelijk worden gesteld.

Leidingen mogen niet klemmen of beschadigd zijn. Alle afdichtelementen volgens voorschrift aanbrengen.

Bij gebruik van de aanhanger wordt het mistachterlicht van het voertuig uitgeschakeld.

Een contactdoosadapter mag uitsluitend bij het rijden met aanhangwagen worden gebruikt.

- De uitval van de aanhangerknipperlichten wordt door
- een akoestisch signaal gemeld.

De controle van de aanhangerfuncties met een aanhanger of een testapparaat met belastingsweerstand uitvoeren.

Opgelet! Zorg ervoor dat voor de werking met aanhangwagen aan alle eisen van de voertuigfabrikant i.v.m. veranderingen en wijzigingen aan het voertuig en/of koelsysteem werd voldaan.

De Duitse tekst van deze handleiding is bindend.

Wijzigingen voorbehouden.

Proszę przestrzegać krajowych wytycznych dotyczących odbioru technicznego.

Wszelkie zmiany lub przebudowy instalacji elektrycznej są zabronione. Spowodują one utratę ważności świadectwa homologacji. Przed rozpoczęciem pracy należy przeczytać instrukcję montażu.

Ważne: Sprawdzić zawartość zestawu przed rozpoczęciem instalacji i zgłosić ewentualne odchylenia. Rozpocząć instalację jeżeli zestaw jest kompletny.

Instalacja elektryczna do haka holowniczego może zostać zamontowana wyłącznie przez firmę specjalistyczną. W przypadku nieprawidłowego montażu istnieje poważne ryzyko wypadku!

Firma WESTFALIA-Automotive nie ponosi odpowiedzialności za obrażenia oraz szkody materialne, wzgl. straty spowodowane instalacją lub nieprawidłowym montażem bądź użytkowaniem produktu.

Prace na poduszki powietrzne powinny być wykonywane wyłącznie przez odpowiednio przeszkolony personel.

Uwaga! Przed rozpoczęciem pracy należy sprawdzić pamięć błędów i w razie potrzeby zastosować urządzenie utrzymujące prąd ciągły. W przeciwnym razie może dojść do utraty danych elektronicznych. Odłączyć akumulator w celu uniknięcia uszkodzeń w instalacji elektrycznej pojazdu.

Ważna wskazówka: Moduł przyczepty jest przystosowany do przeprowadzania diagnozy. W przypadku gdy procesy diagnostyczne przeprowadzane przez producenta lub mechanizmy kontrolne wspomagane przez oprogramowanie doprowadzają do generowania protokołów błędów mających związek pośredni lub bezpośredni z trybem przyczepty, z kompletu przewodów gniazda przyczepty odłączyć należy moduł przyczepty, a następnie powtórnie przeprowadzić procedurę diagnostyczną.

Nie przejmuje się żadnej odpowiedzialności z tytułu wprowadzania technicznych zmian i aktualizacji oprogramowania, które zostały dokonane np. przez producenta pojazdu od chwili pierwszego uruchomienia i które generują błędy podczas eksploatacji przyczepty.

Przewody nie mogą być zaciśnięte ani uszkodzone. Prawidłowo zamontować wszystkie elementy uszczelniające.

Podczas holowania przyczepty odłączone jest tylne światło przeciwmgielne.

Adapter gniazda może być używany tylko podczas holowania przyczepty.

- Awarię kierunkowskazów przyczepty sygnalizuje:
 - sygnał akustyczny.

Funkcje przyczepty należy sprawdzić z podłączoną przycycą lub za pomocą przyrządu kontrolnego z opornością obciążenia.

Uwaga! Należy się upewnić, że zostały spełnione wszystkie wymagania producenta pojazdu dotyczące zmian i doposażania pojazdu i/lub systemu chłodzenia w celu eksploatacji z przycycą.

Tekst niniejszej instrukcji w języku niemieckim jest wiążący.

Zmiany zastrzeżone.

Подлежат соблюдение национальные директивы о порядке приемки навесного/встраиваемого оборудования.

Какие-либо изменения и переделки на электрооборудовании недопустимы. Они делают недействительным разрешение на эксплуатацию.

Перед началом работы прочесть инструкцию по монтажу.

Важно: Проверить содержимое набора перед началом установки и сообщить в случае отклонений. Начинать установку только при наличии полного набора.

К монтажу электрооборудованию сцепного устройства допускаются только специализированные фирмы. При неправильном монтаже грозит опасность тяжелых травм!

WESTFALIA-Automotive не несёт ответственности за ущерб, причинённый людям или имуществу, и соотв. за убытки, причиной которых стали ошибки при установке, монтаже или использовании продукта.

Работа над подушками безопасности должны выполняться только надлежащим образом обученным персоналом.

Внимание – перед началом работы прочесть содержимое накопителя сбоев, при необходимости воспользоваться источником бесперебойного питания во избежание потери сохранённых данных в электронных устройствах. Отсоединить батарею, чтобы предотвратить повреждение электроники автомобиля.

Важное указание: Модуль прицепа имеет функцию диагностики. Если в ходе процессов диагностики производителя или при использовании программных тестовых механизмов составляются протоколы ошибок, которые прямо или косвенно связаны с эксплуатацией прицепа, модуль прицепа необходимо отсоединить от кабелей блока прицепа и запустить новый процесс диагностики.

Гарантийные претензии не принимаются в случае технических изменений, обновлений ПО, которые были произведены после первичной приёмки в эксплуатацию, например, производителем автомобиля и привели к неправильной работе прицепа.

Не допускать заземления и повреждения электропроводки. Все уплотнения устанавливать как положено.

При пользовании прицепом отключать на тягаче заднюю противотуманную фару.

Пользоваться розеточным переходником только при работе с прицепом.

- Выход из строя фонарей указателей поворота для прицепа
 - сопровождается звуковым сигналом.

Проверку работы прицепа вести с самим прицепом или пробником с нагрузочными сопротивлениями.

Внимание! Необходимо удостовериться, что выполнены все требования производителя автомобиля по изменениям и дополнительному оснащению автомобиля и/или системы охлаждения для эксплуатации с прицепом.

Обязательным является немецкий текст данной инструкции.

Право на внесение изменений сохраняется.

Nationella riktlinjer beträffande monteringen skall beaktas.

All form av ändring respektive ombyggnad på elsystemet är förbjuden. Förändringar resulterar i att körtillståndet upphör att gälla. Läs igenom monteringsanvisningarna innan arbetet påbörjas.

Viktigt: Kontrollera setets innehåll innan du börjar med installationen och rapportera i förekommande fall avvikelser. Börja med installationen först när du har ett komplett set.

Elsystemet för dragkroken får endast monteras av kvalificerade tekniker. Vid felaktig montering föreligger risk för allvarliga olyckor!

WESTFALIA-Automotive tar inte ansvar för personskador eller materiella skador resp. förluster, som förorsakats av installationen eller en felaktig montering eller användning av produkten.

Arbete på krockkuddar bör endast utföras av utbildad personal.

Obs – innan arbetet påbörjas, läs av felminnet och använd vid behov enheten för bibehållning av vilostrom, annars kan elektroniskt sparade data gå förlorade. Frånkoppla batteriet för att undvika skador på fordons elektronik.

Viktigt anvisning: Släpvagnsmodulen kan diagnosticeras. Om tillverkarens diagnosprocesser eller programstödda testmekanismer genererar felrapporter, som direkt eller indirekt står i samband med driften av släpet skall släpvagnsmodulen skiljas från kablarna till släpvagnsdosan och en ny diagnosprocess skall startas.

Ingen garanti ges för tekniska ändringar, programuppdateringar, som genomförs efter idrifttagningen för första gången, t.ex. av fordonstillverkaren och som leder till felfunktioner vid användningen av släpet.

Ledningarna får inte vara klämda eller skadade. Montera alla tätningselement korrekt.

När släpvagnen är påhängd släcks dragfordonets dimbakljus.

Stickdosadaptern får bara användas i kombination med släpvagn.

- Om blinkersljusen på släpvagnen slutar att fungera indikeras detta
- med en akustisk larmsignal.

Släpvagnsfunktionerna ska kontrolleras med hjälp av en påhängd släpvagn eller en provningsutrustning med belastningsmotstånd.

Observera! Det skall säkerställas att samtliga krav från fordonstillverkaren gällande ändringar på och kompletteringsutrustning av fordonet och/eller kylsystemet för användning med släp har genomförts.

Den tyska texten i denna anvisning är bindande.

Ändringar förbehålls.

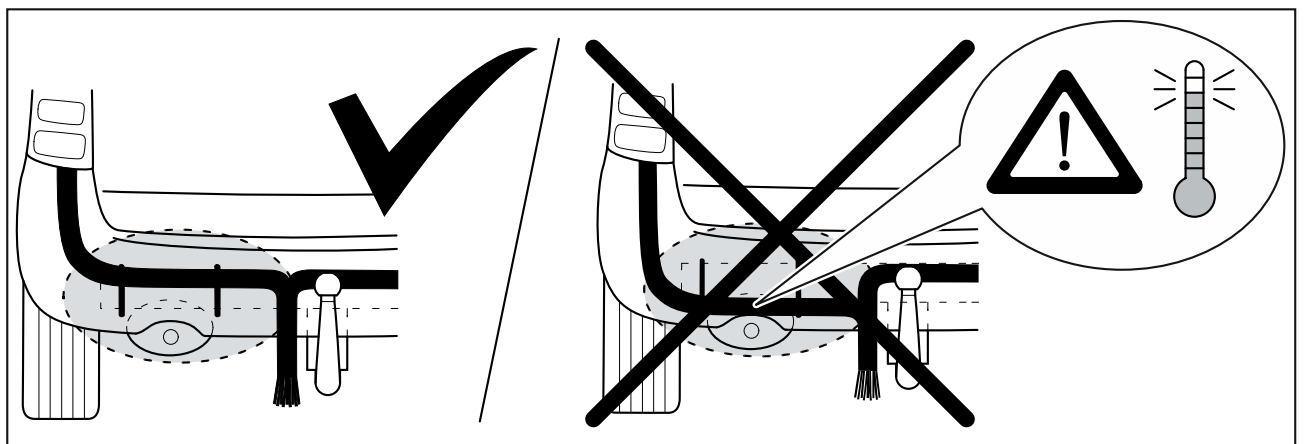
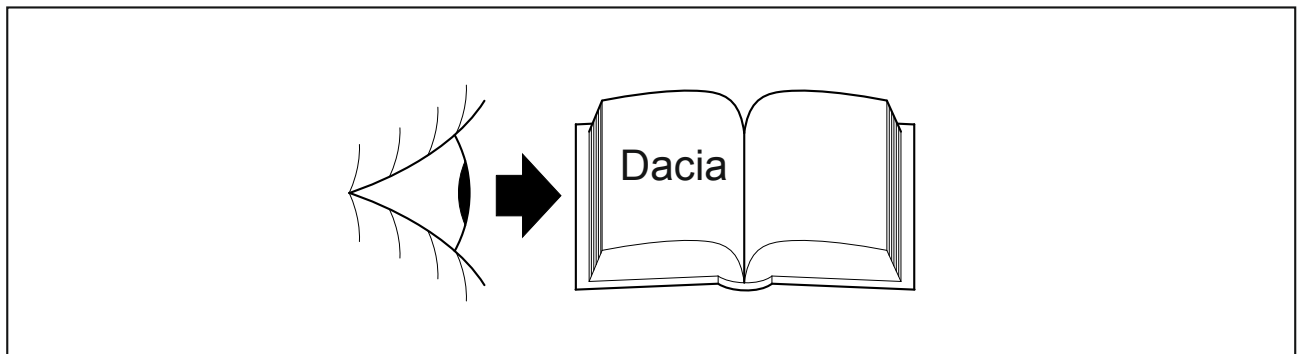

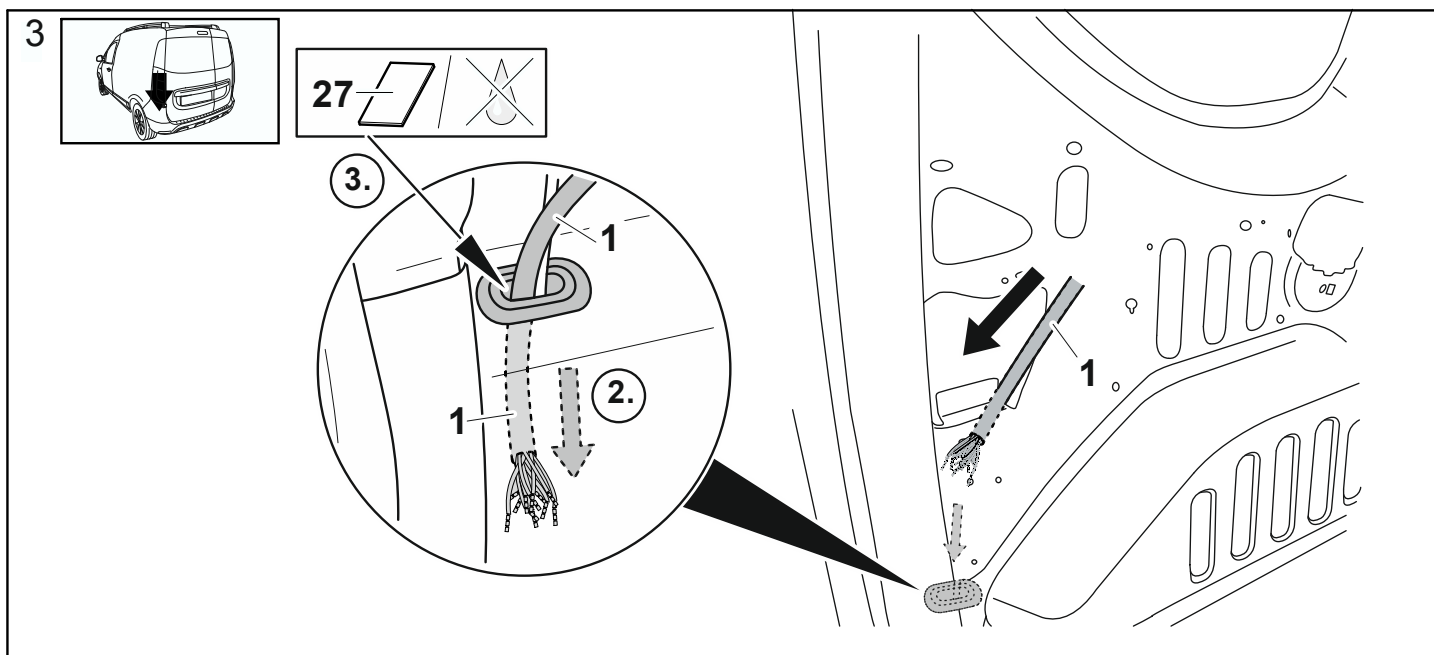
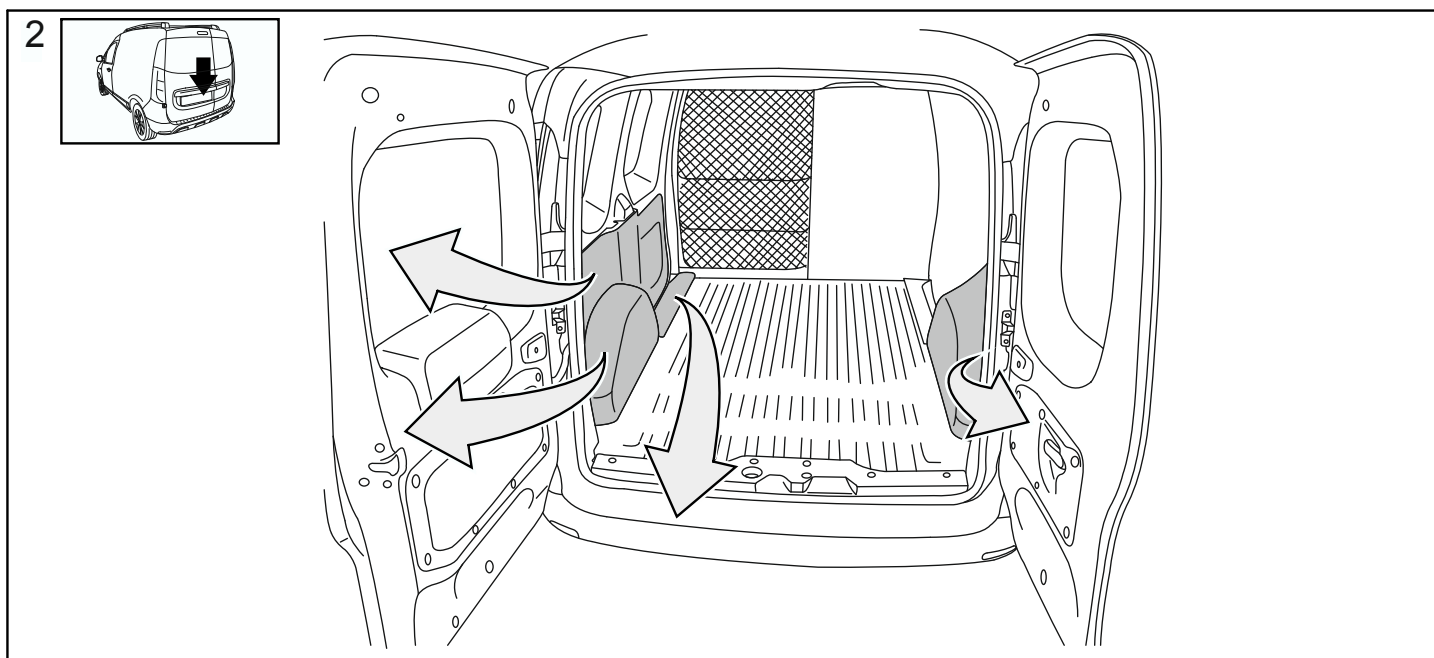
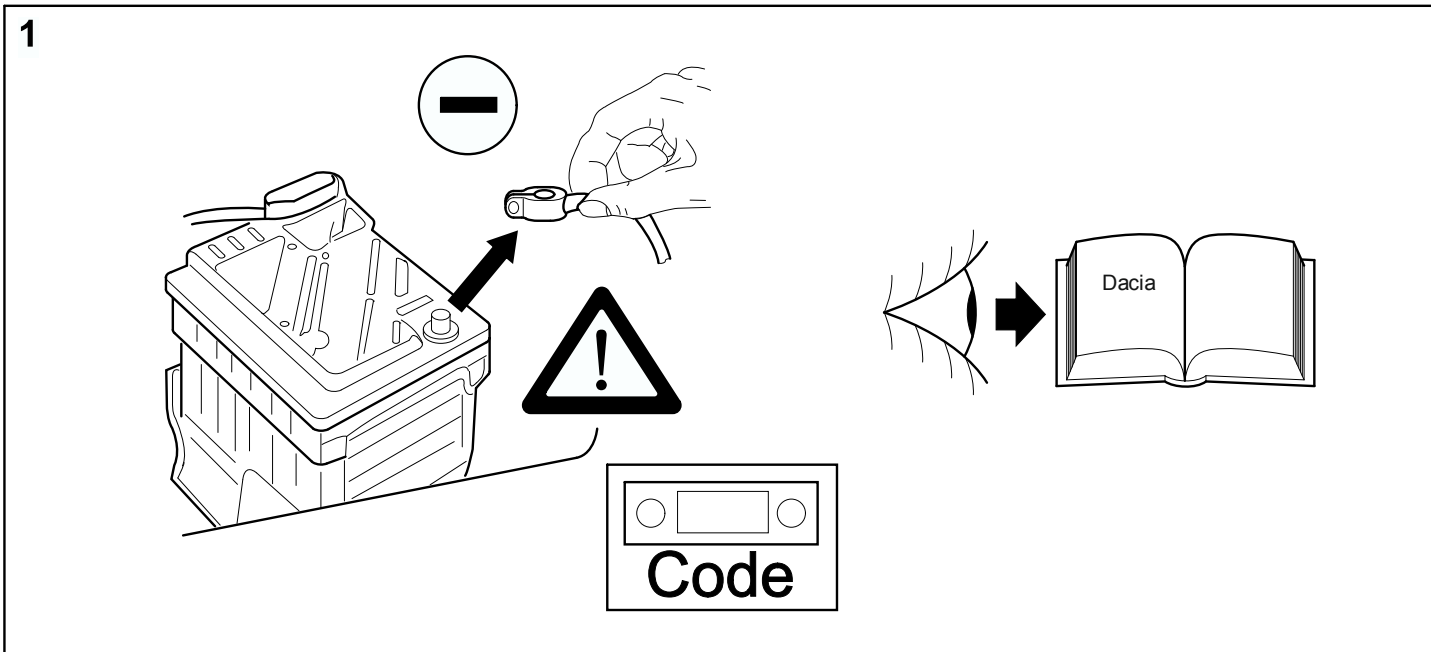

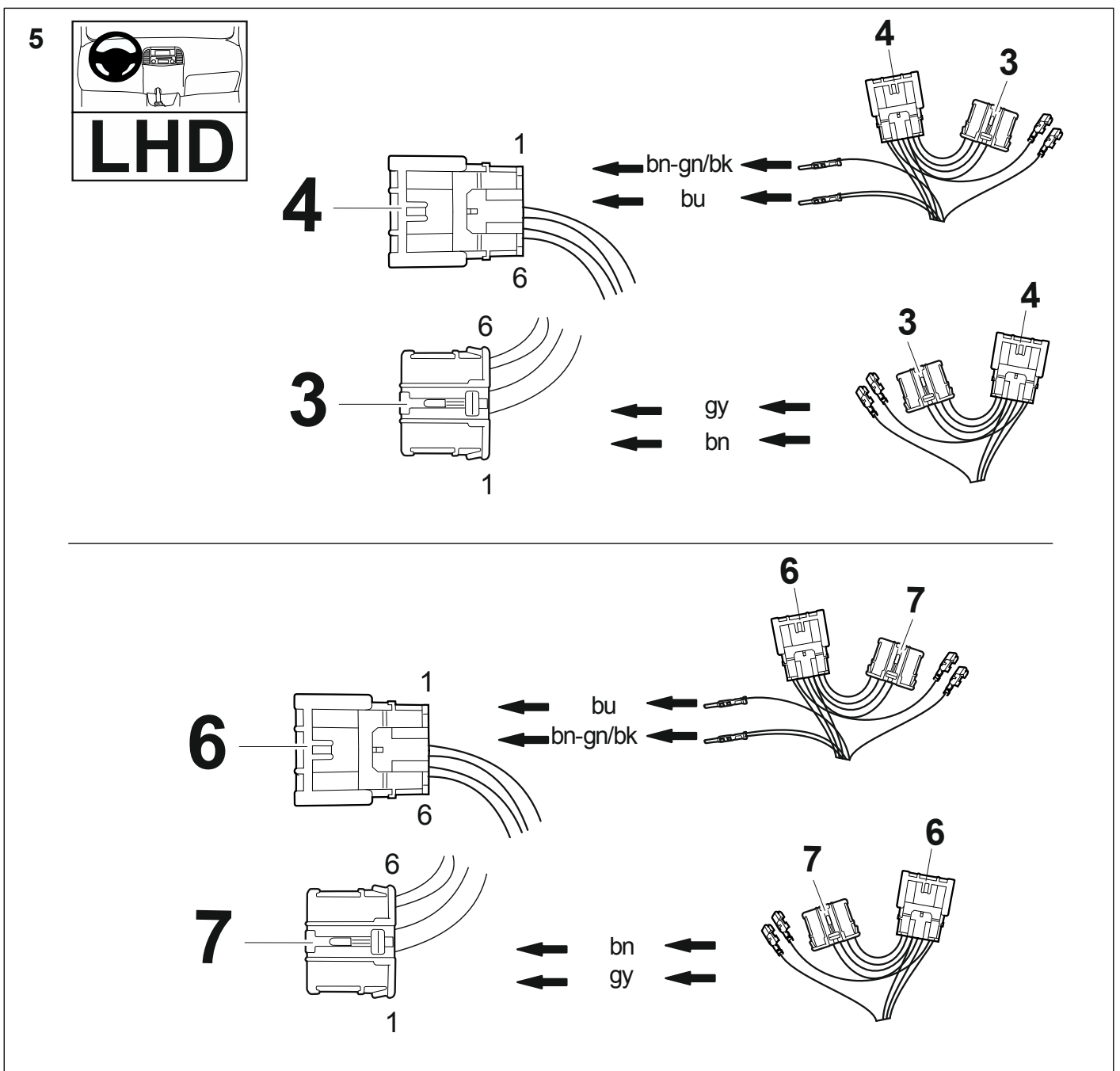
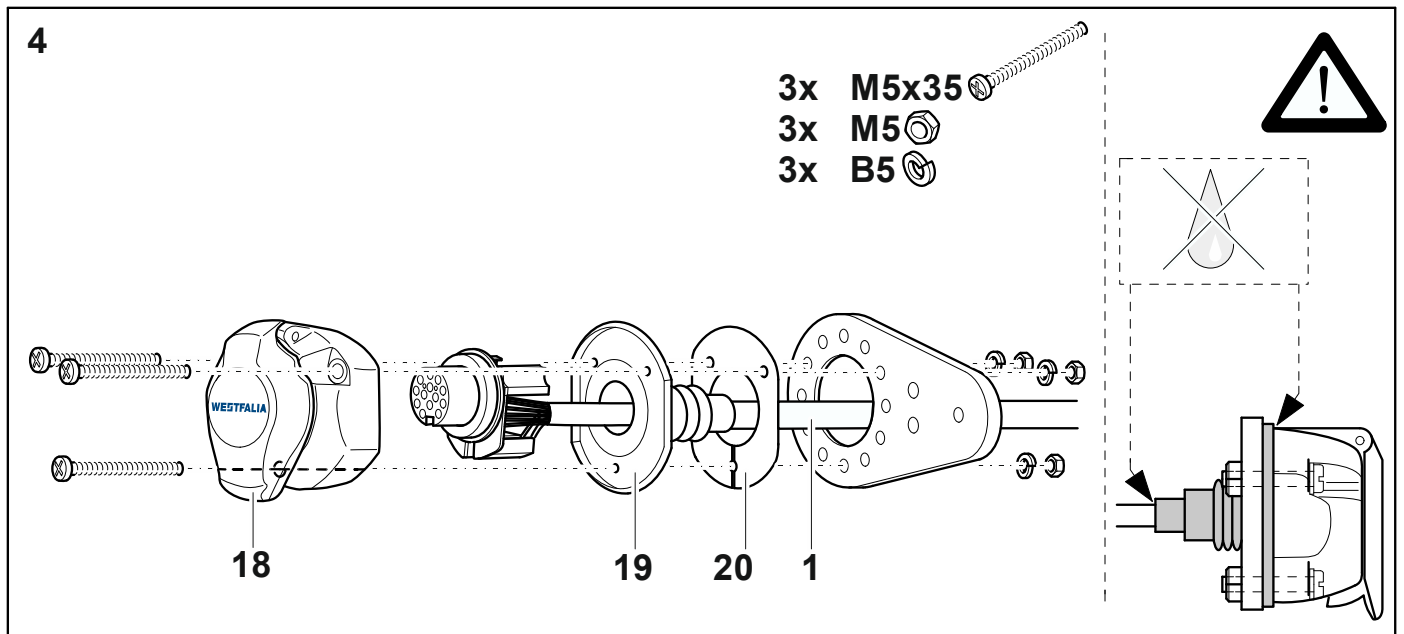

6

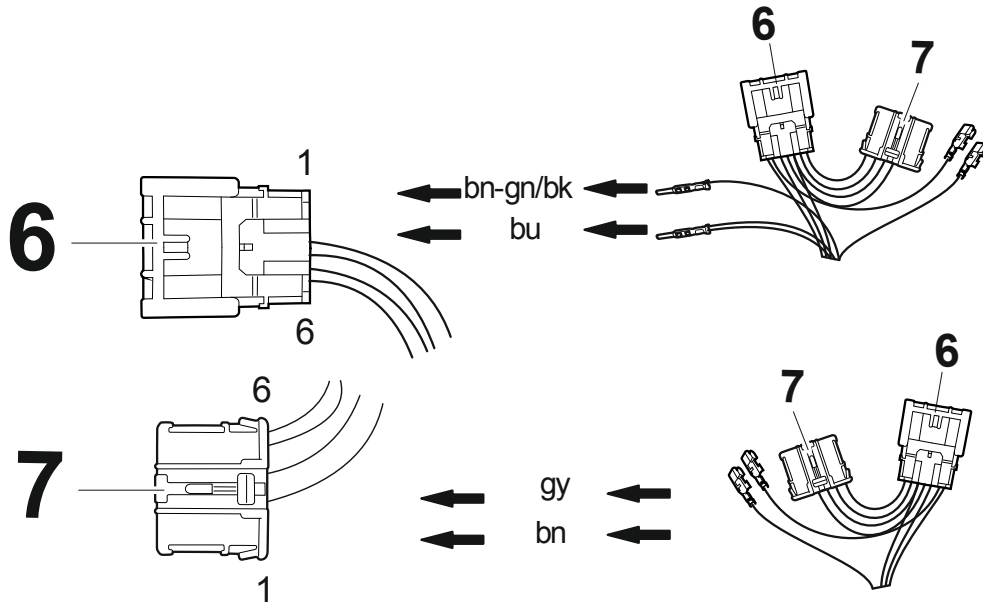
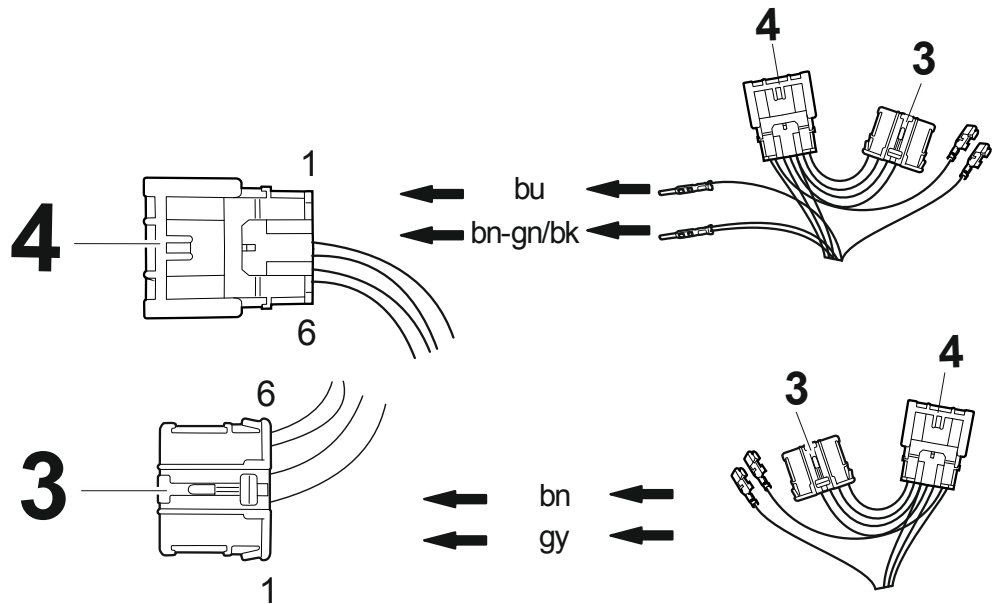
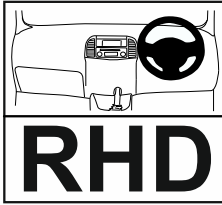

7

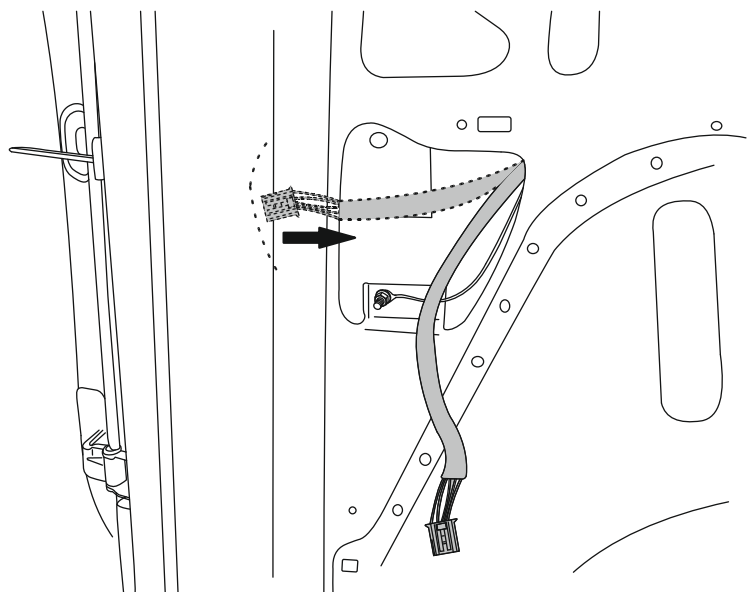
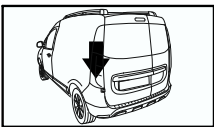

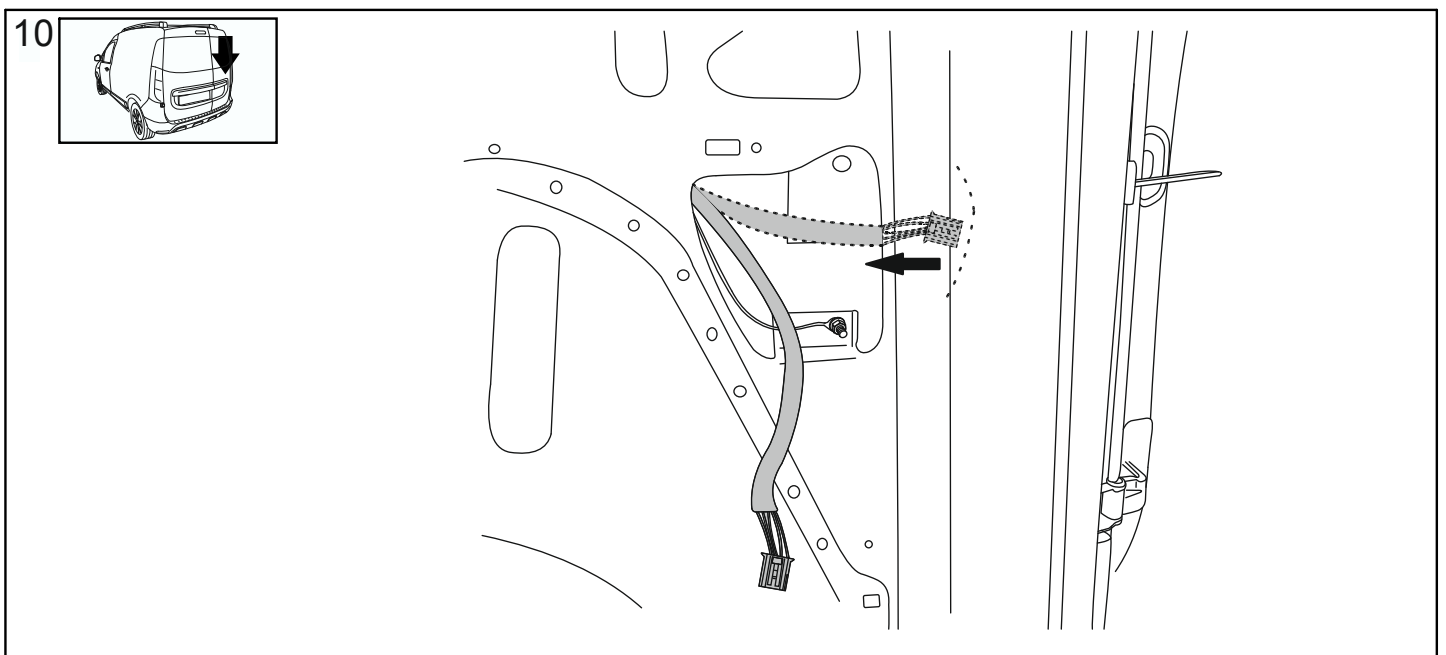
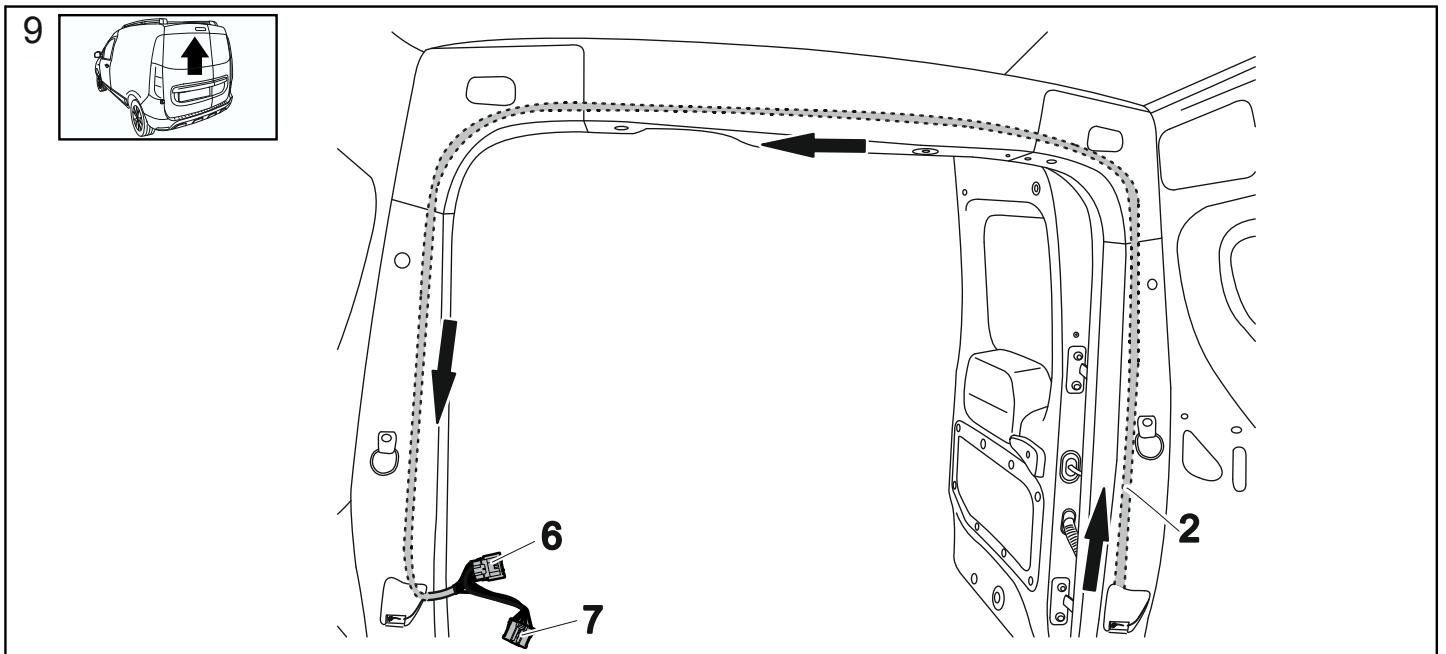
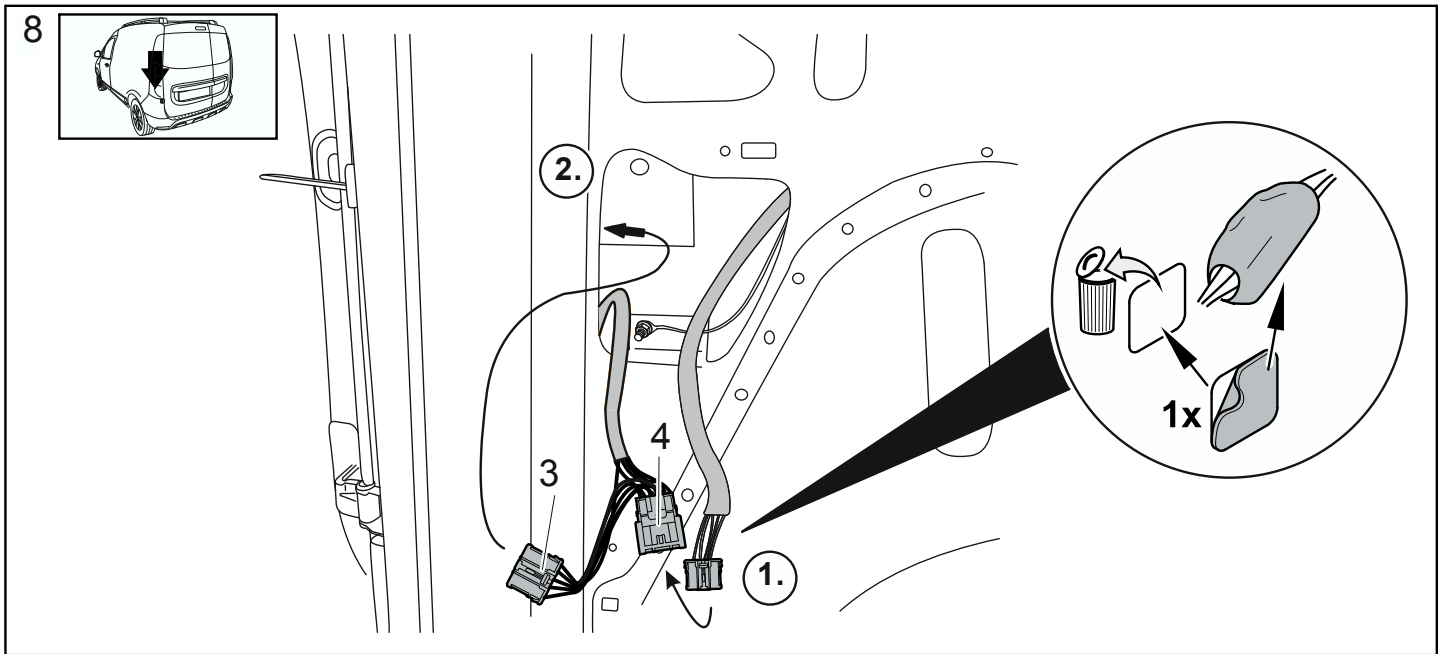

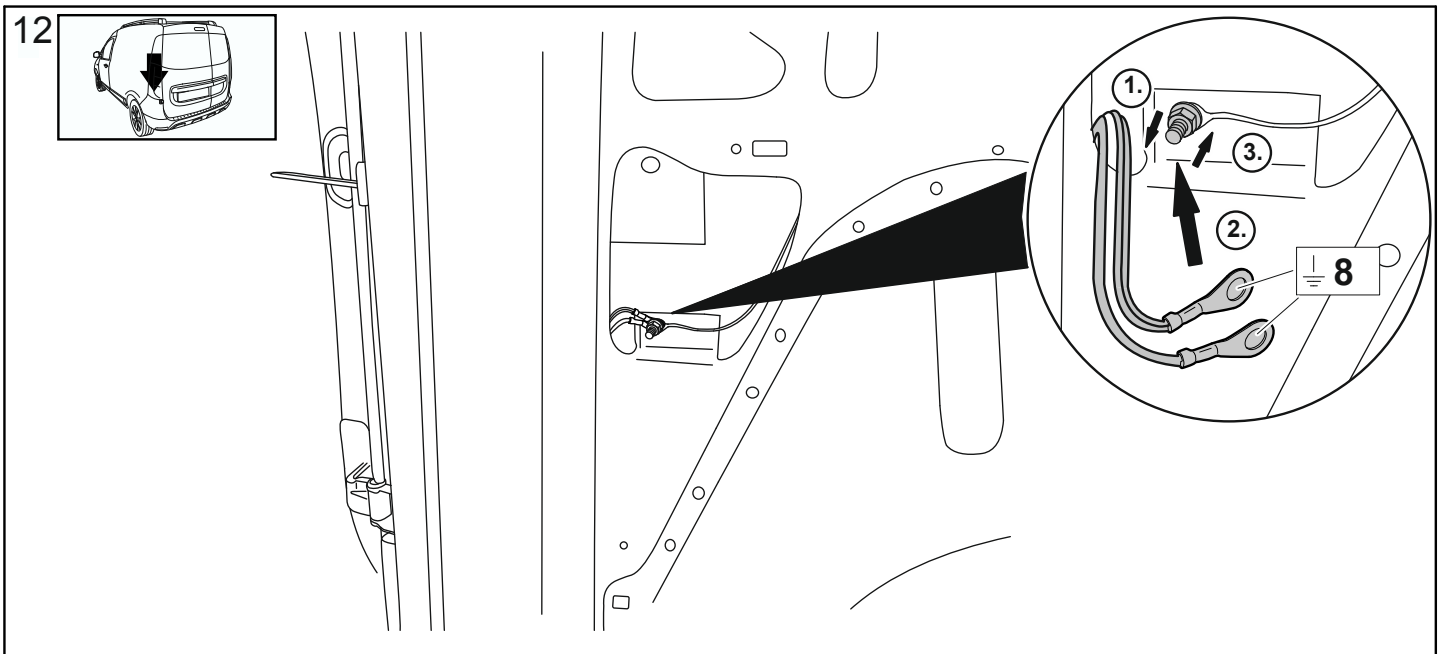
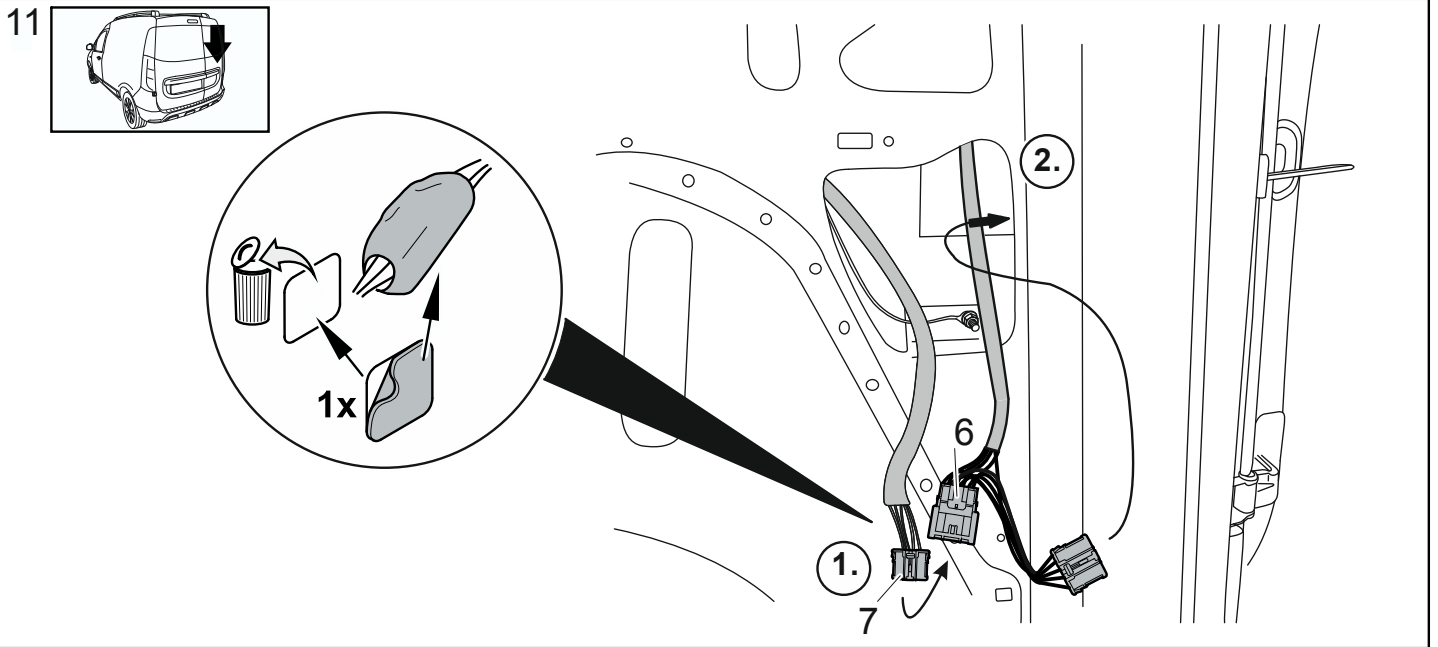

13

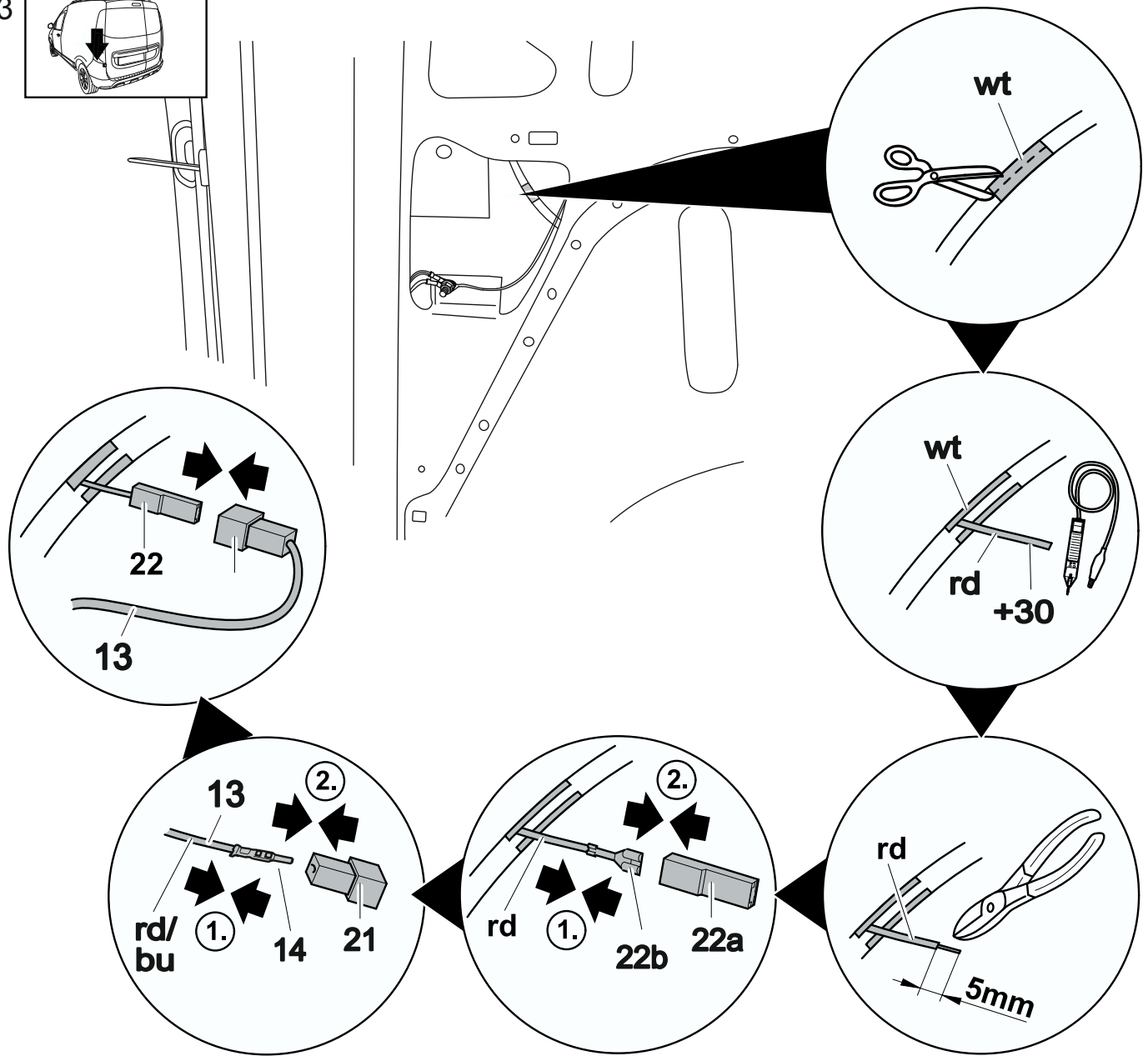
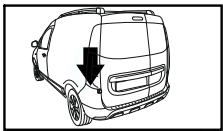

14

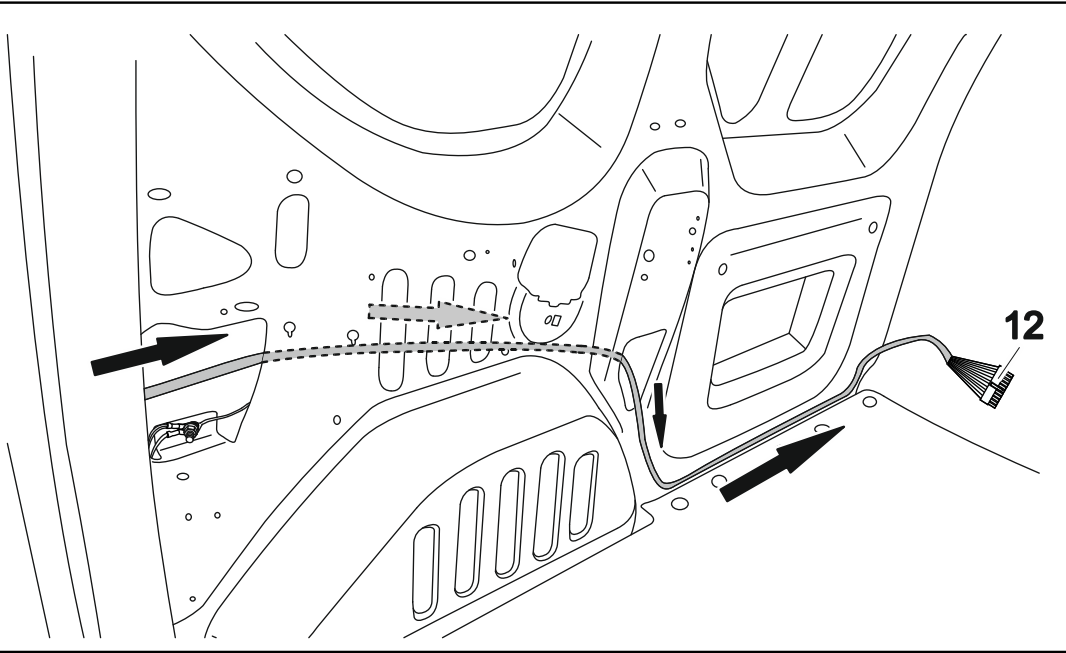
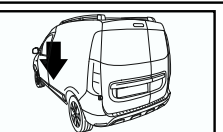

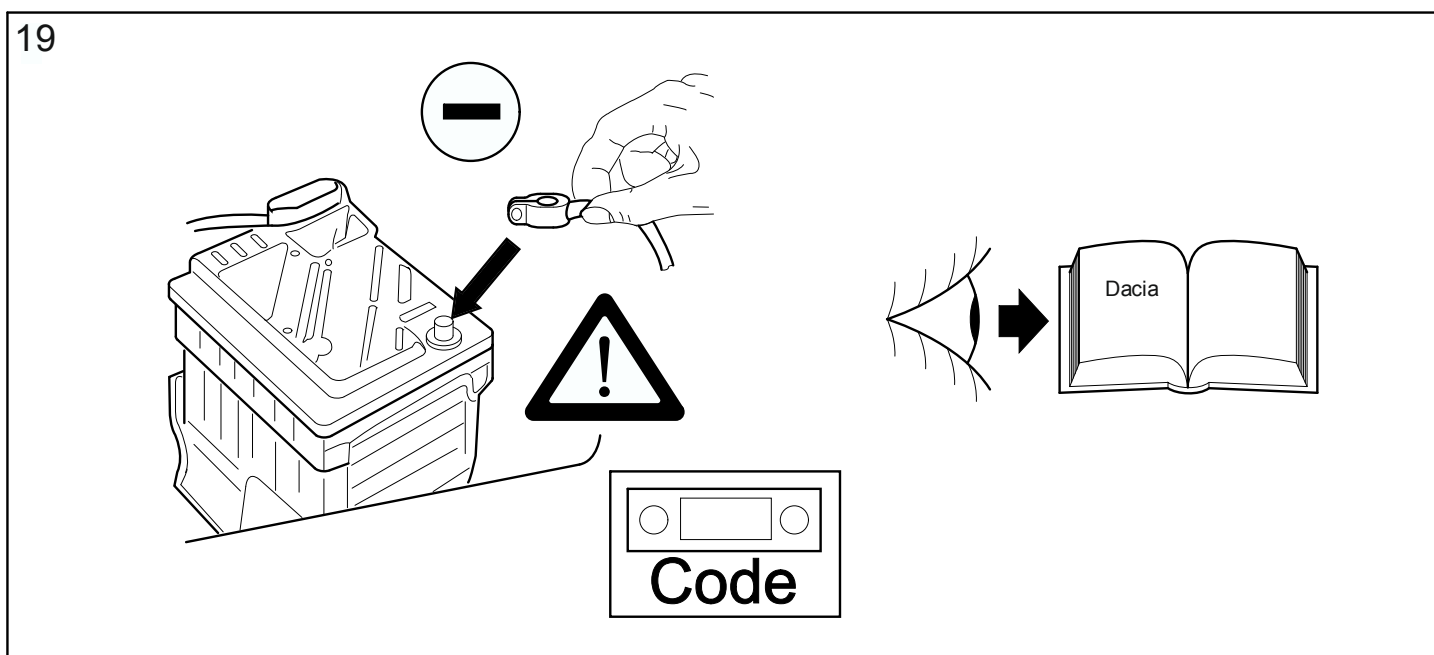
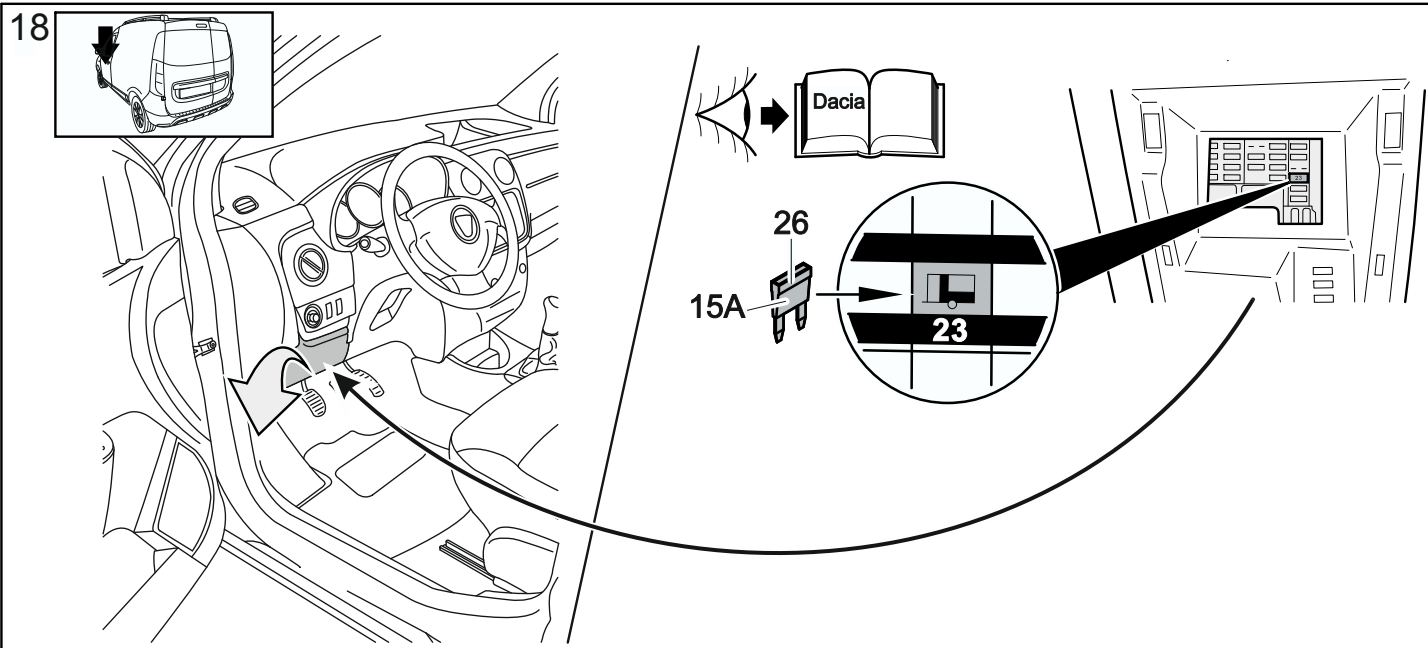

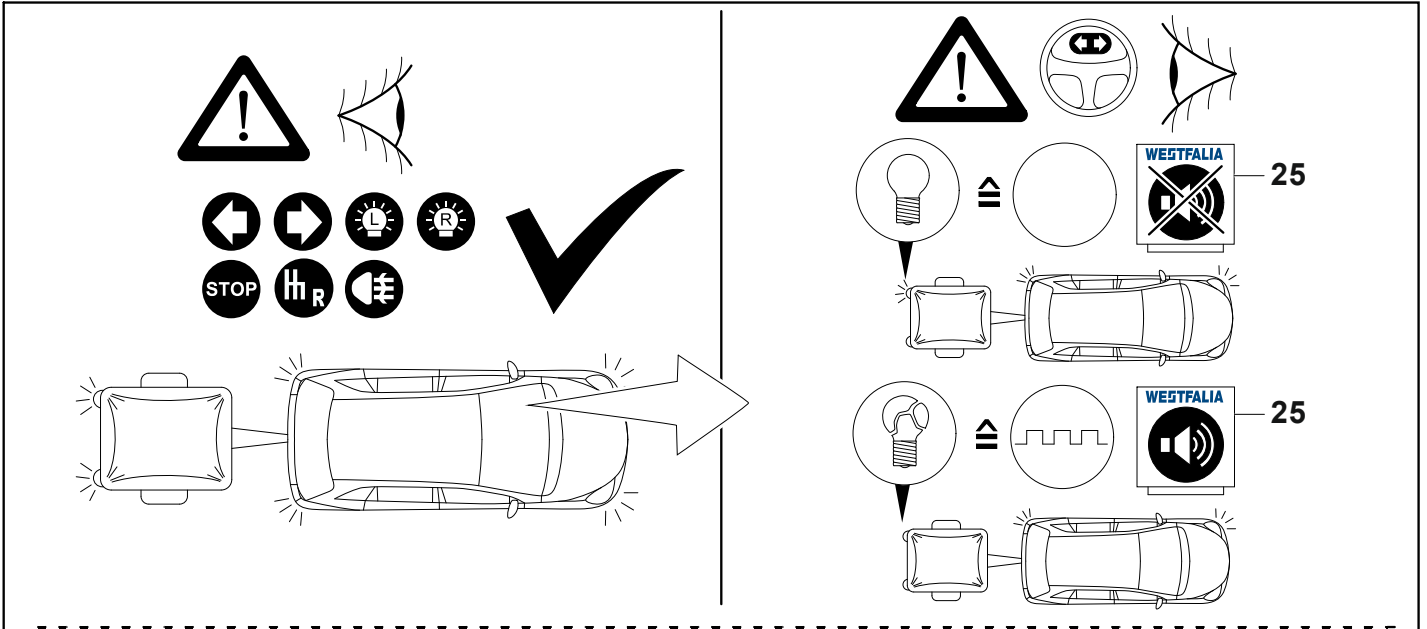
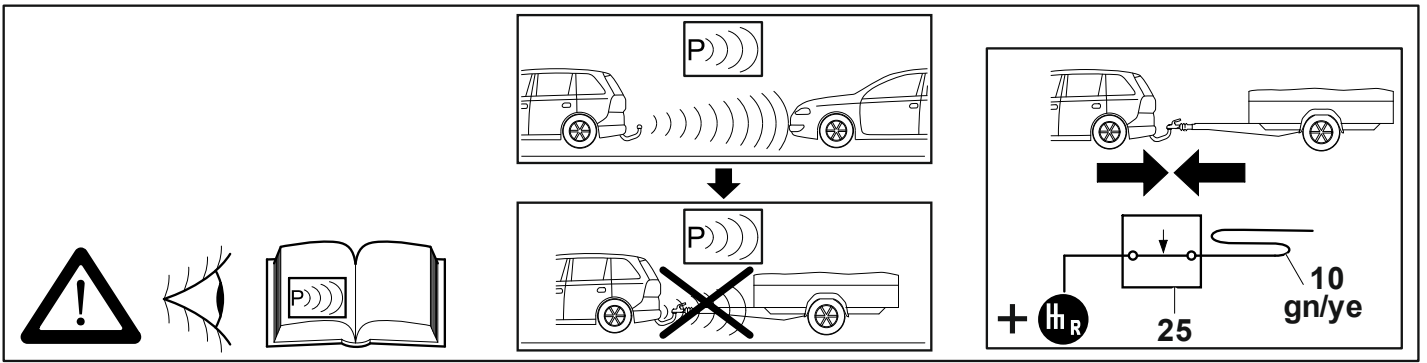

WESTFALIA

Trailer simulation for carcheck 7-pin and 13-pin
 WA no.: 900 001 300 199

