

Notice de pose du faisceau électrique pour
crochet d'attelage avec prise 13 voies

Version : 5 DOORS
Année : 01/2008 →
Réf : 173730

RENAULT Grand Modus



0 H 45

Einbauanleitung elektrosatz Anhängervorrichtung mit Steckdosen 13-Polig
Fitting instructions electric wiringkit towbar with socket 13-pin
Montage-handleiding elektrokabelset voor trekhaak met contactdoos 13-polig

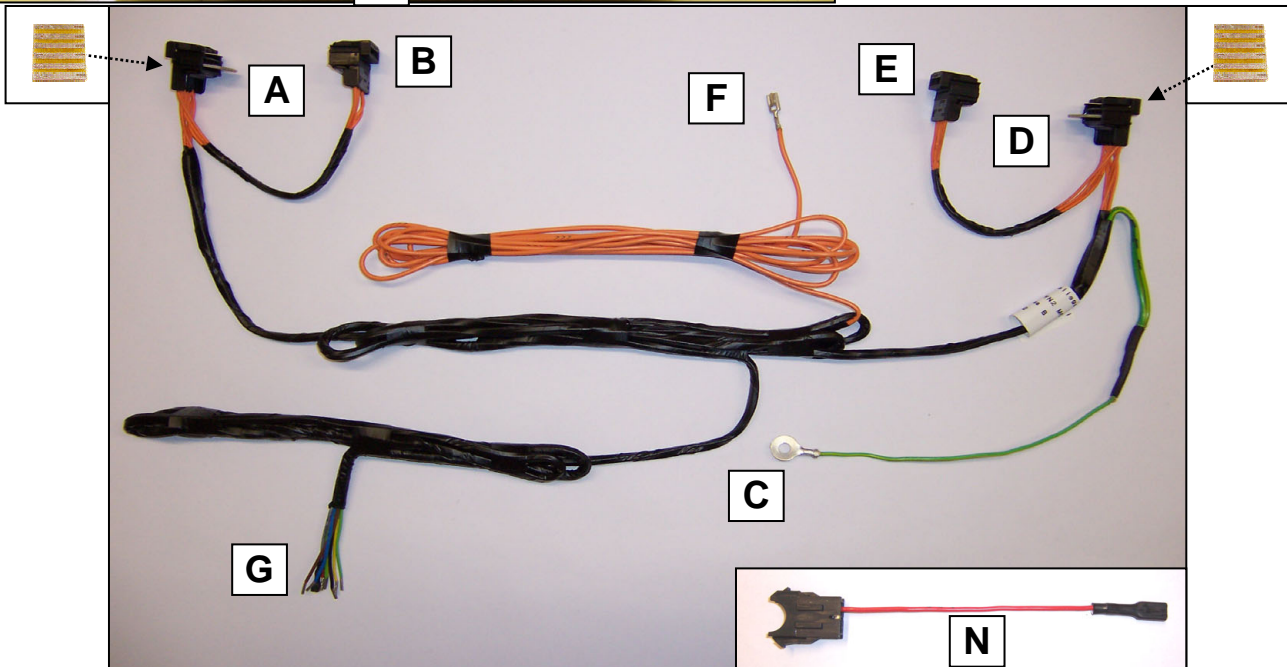
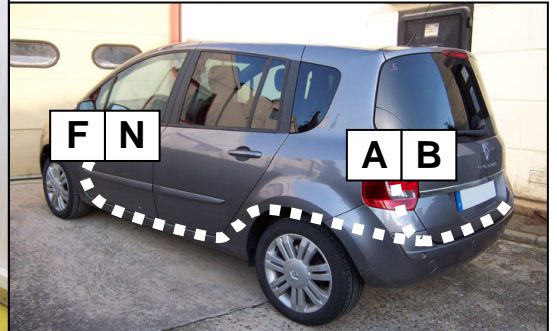
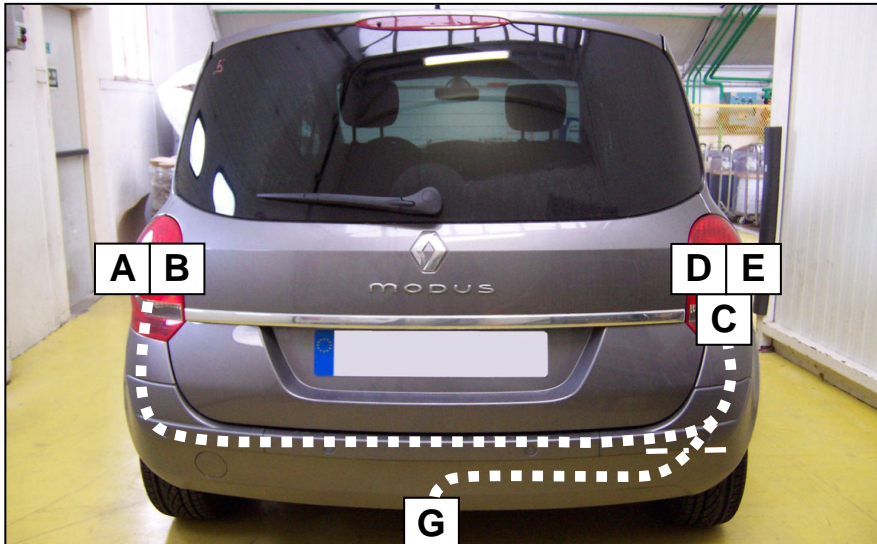

Liste des pièces / Teilliste / Part list / Onderdelenlijst :

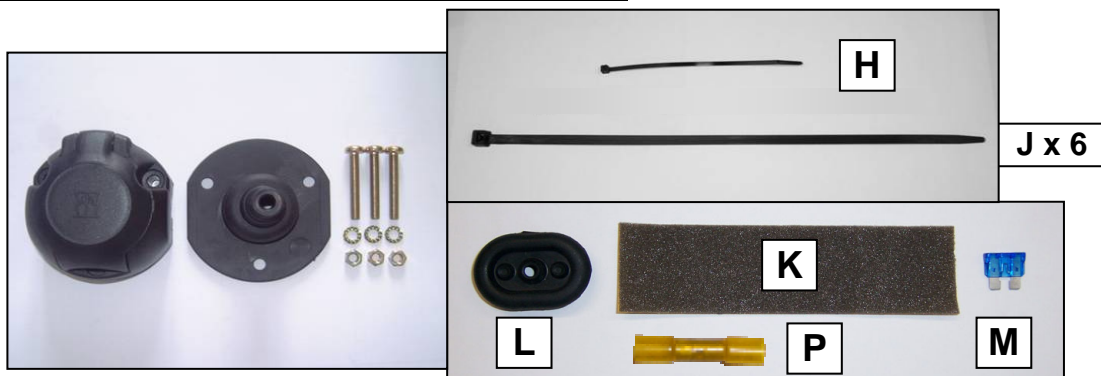

Cette notice ne peut être divulguée ou reproduite, partiellement ou en totalité, sans accord de la société.

1

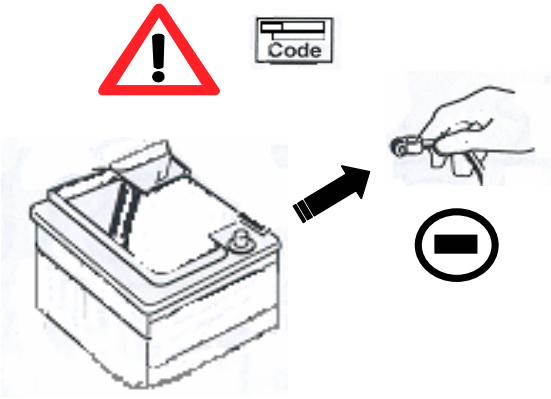

2

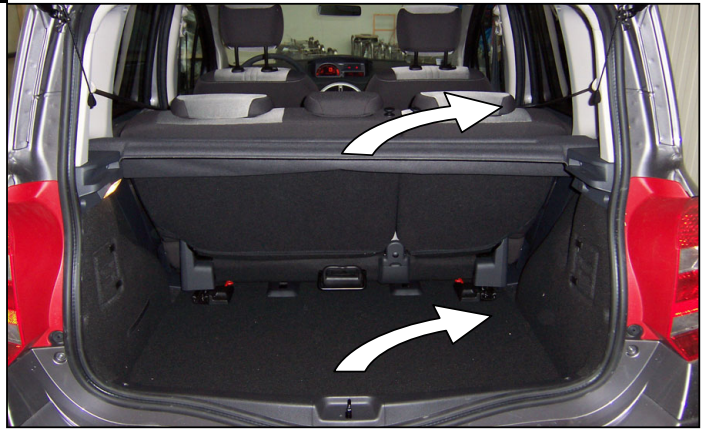

3



4

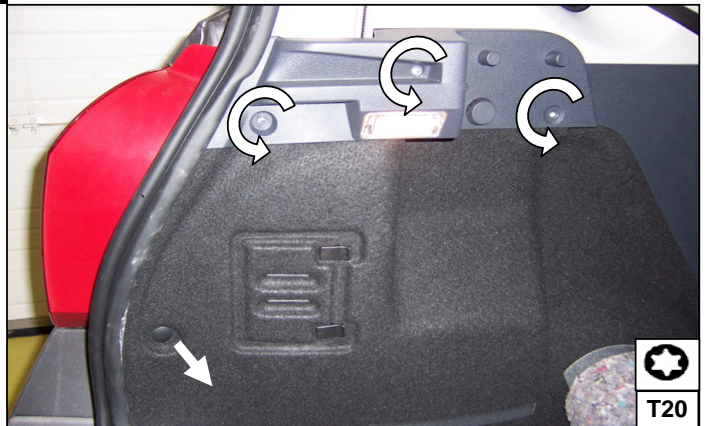

5

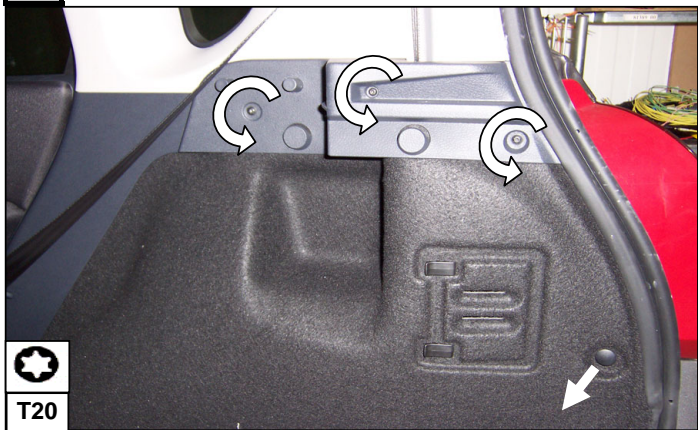

6



7

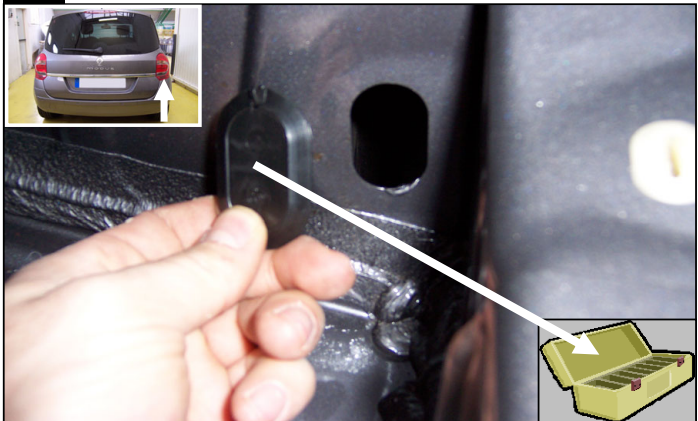

8

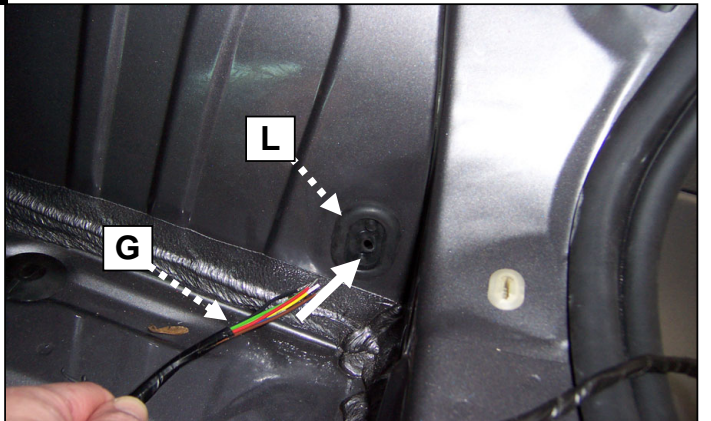

9

	1/L	2/54g	3/31	4/R	5/58R	6/54	7/58L	8	9	13	(C)
	21+5 W	21W	1 mm ²	21+5 W	40 W	63 W	40 W	42 W	100 W	2 mm ²	
F	Jaune	Bleu	Vert/jaune	Vert	Marron	Rouge	Noir	Blanc	Orange	Vert/jaune	Gris
D	Gelb	Blau	Grün/gelb	Grün	Braun	Rot	Schwarz	Weiß	Orange	Grün/gelb	Grau
GB	Yellow	Blue	Green/yellow	Green	Brown	Red	Black	White	Orange	Green/yellow	Grey
NL	Geel	Blauw	Groen/geel	Groen	Bruin	Rood	Zwart	Wit	Oranje	Groen/geel	Grijs
P	Amarelo	Azul	Verde/amarelo	Verde	Castanho	Vermelho	Preto	Branco	Cor de laranja	Verde/amarelo	Cinzento
I	Giallo	Blu	Verde/giallo	Verde	Marrone	Rosso	Nero	Bianco	Arancio	Verde/giallo	Grigio
E	Amarillo	Azul	Verde/amarillo	Verde	Marron	Rojo	Negro	Blanco	Anaranjado	Verde/amarillo	Gris

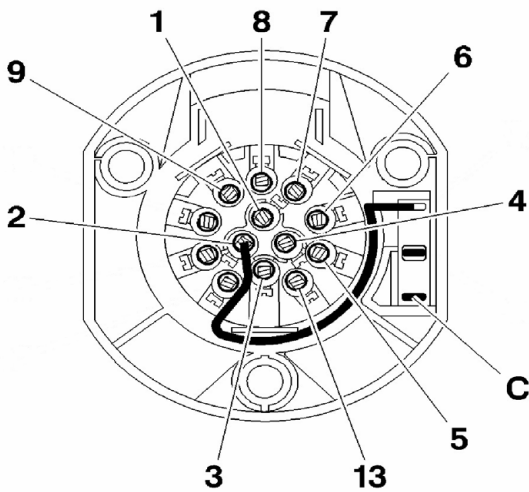

10

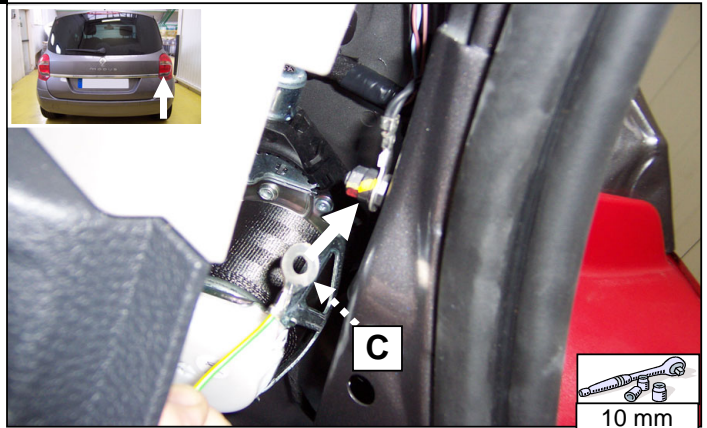

11

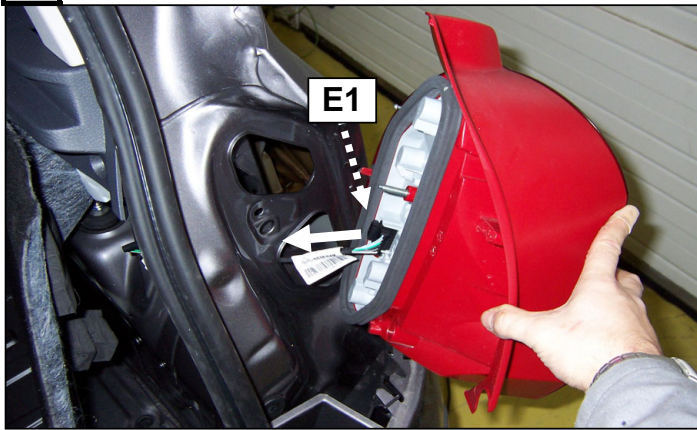

12

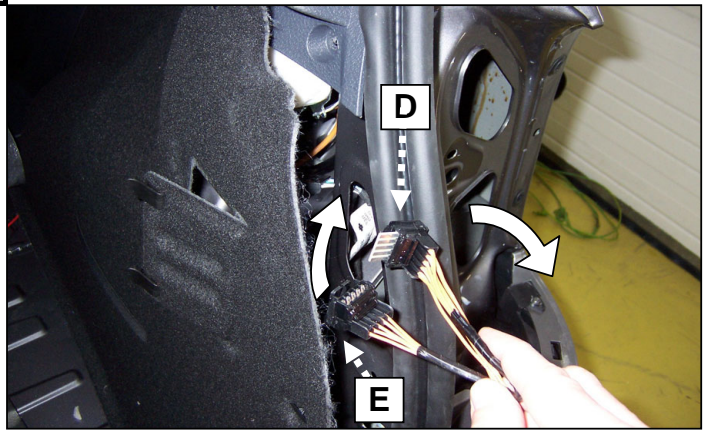

13

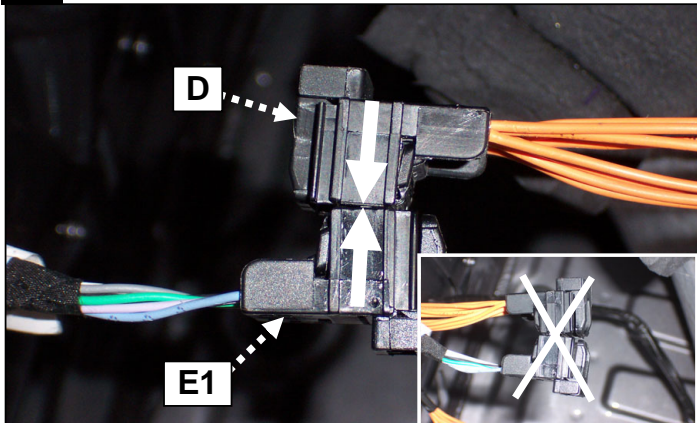

14

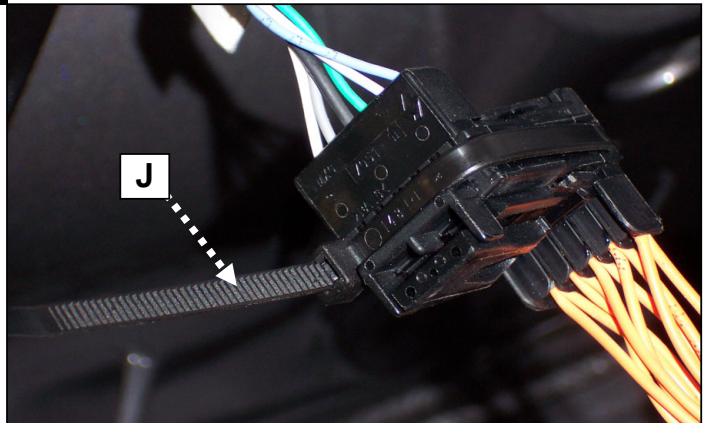

15

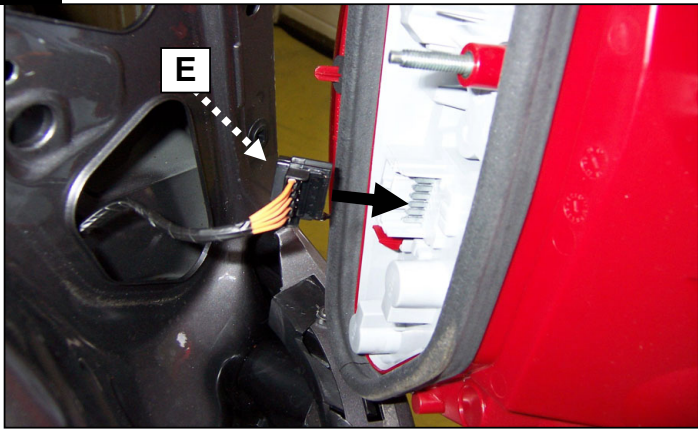

16

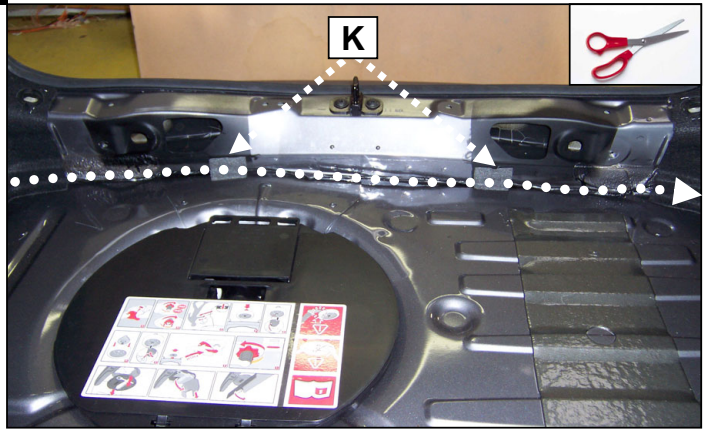

17

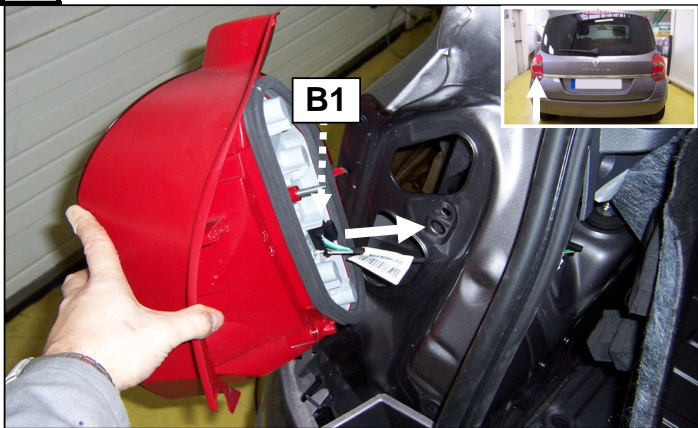

18

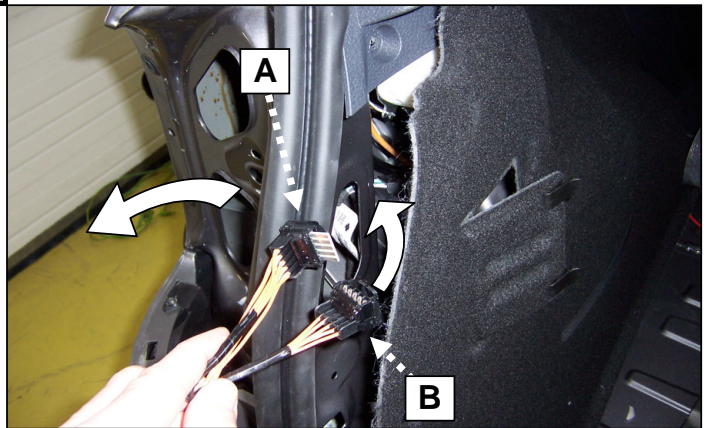

19

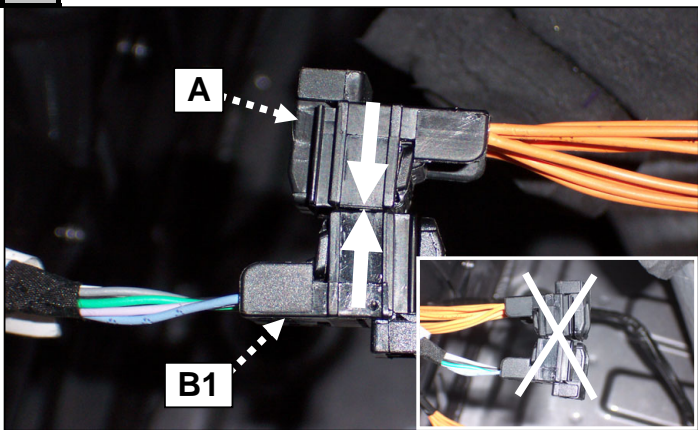

20

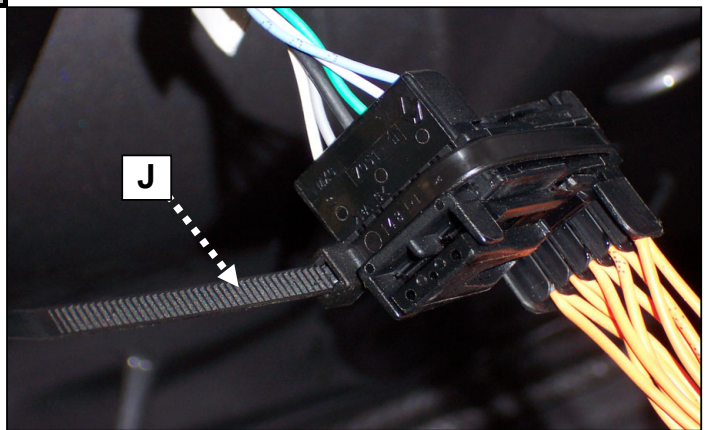

21

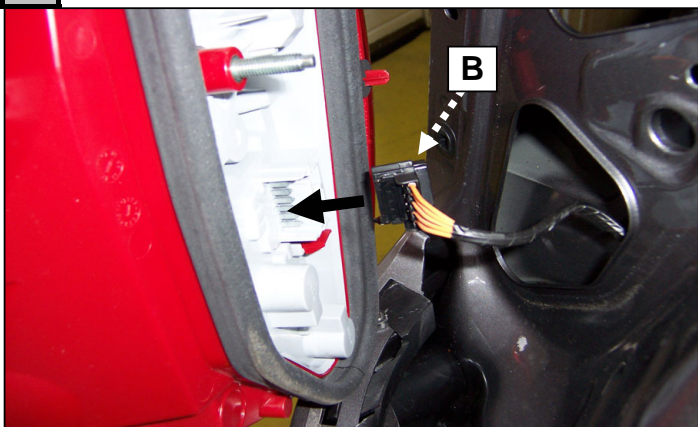

22

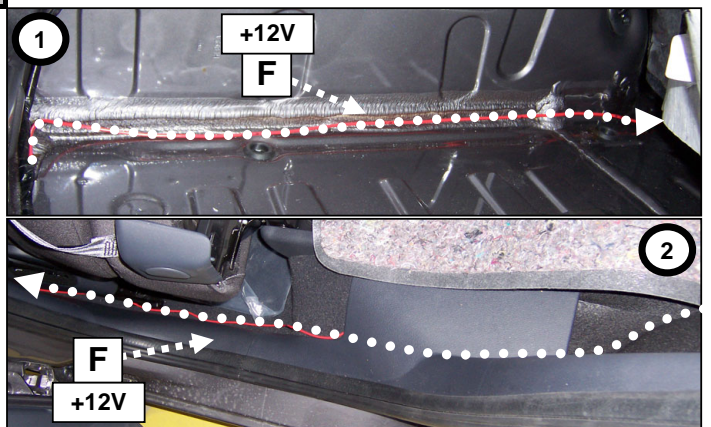

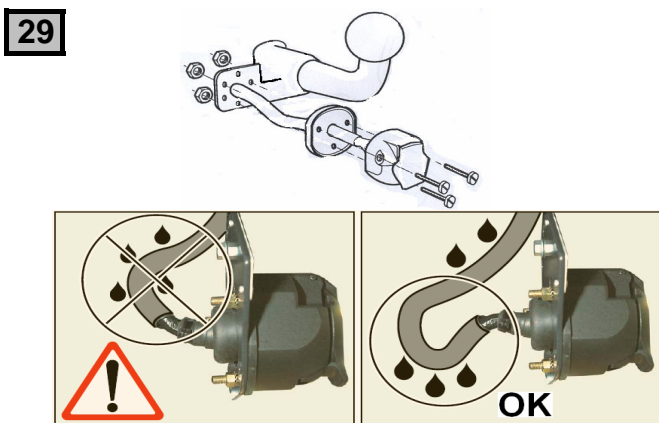
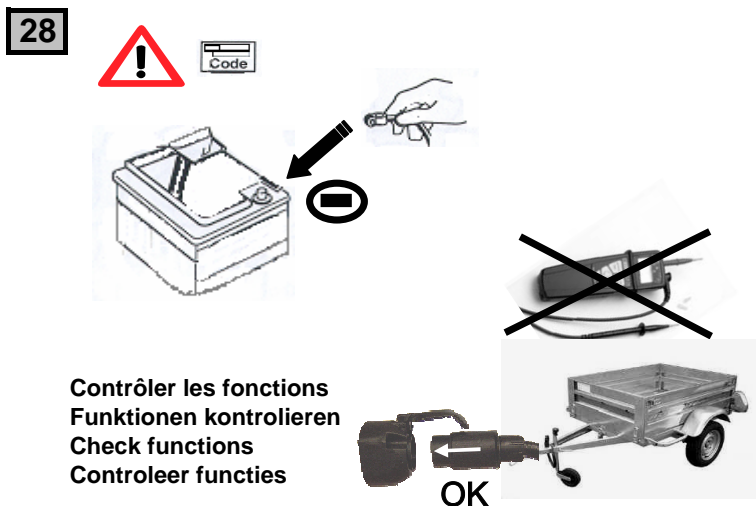
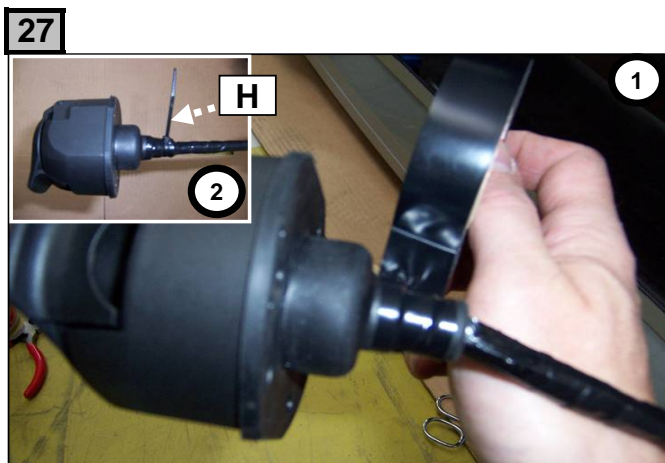
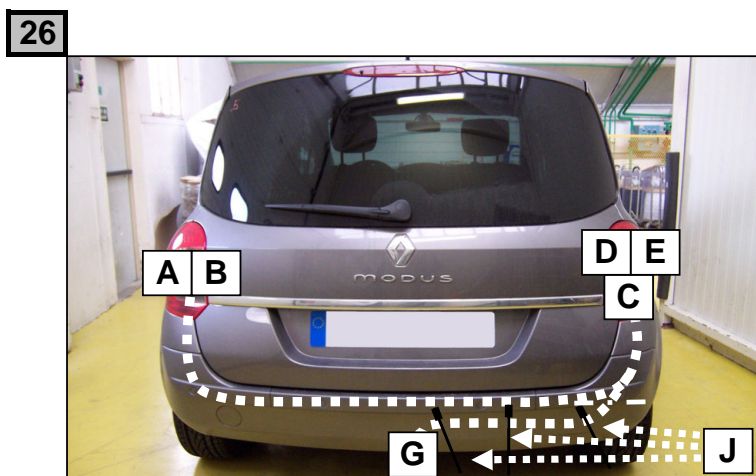
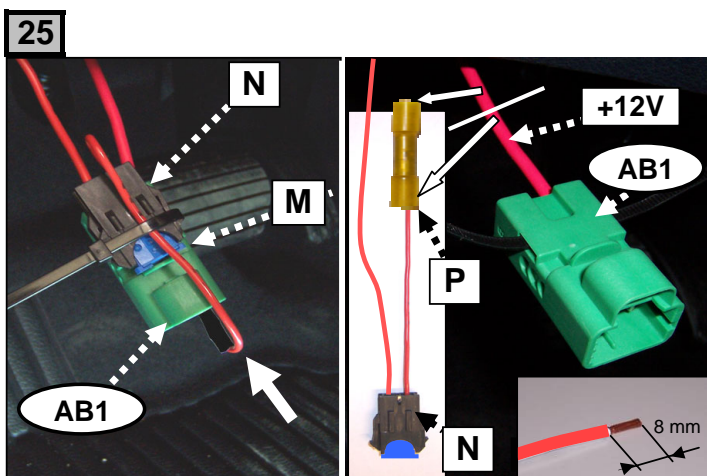
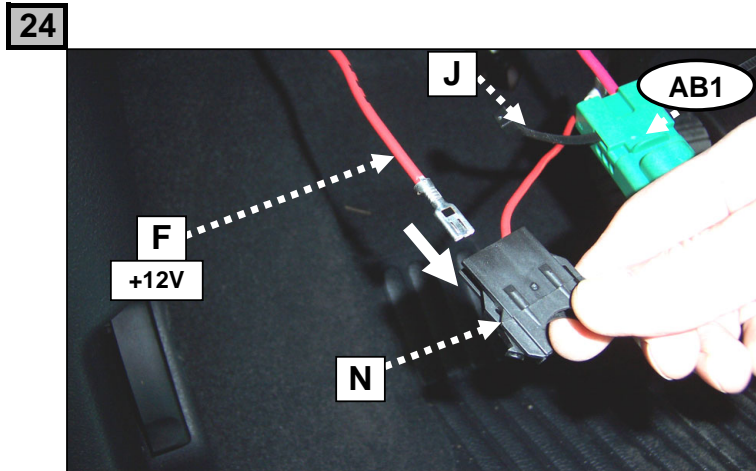
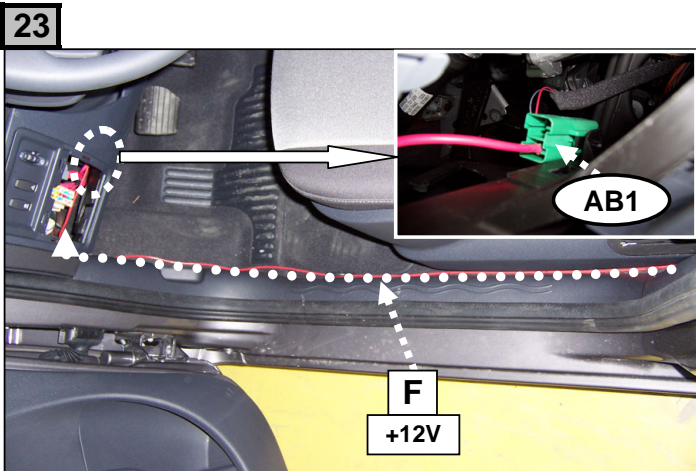

Lors du branchement de la remorque ,désactiver le système "RADAR DE RECUL" au tableau de bord
When you connect the trailer, do remove the function "PARK ASSIST" on the dashboard